

## User's Guide



# Fireface 800

The most powerful FireWire® audio interface ever!

**DVD**  
24 Bit / 192 kHz ✓ *ready*

**TotalMix™**



**SyncAlign™**

**ZLM™**

**SyncCheck™**



**SteadyClock™**



FireWire 800 / 400 Digital I/O System  
10 + 16 + 2 Channels Analog / ADAT / SPDIF Interface  
24 Bit / 192 kHz Digital Audio  
56 x 28 Matrix Router  
MIDI I/O  
Stand-Alone Operation  
MIDI Remote Control  
Stand-Alone MIDI Controlled Operation

---

▶	<b>Important Safety Instructions</b> .....	5
---	--	---

▶ **General**

<b>1</b>	<b>Introduction</b> .....	8
<b>2</b>	<b>Package Contents</b> .....	8
<b>3</b>	<b>System Requirements</b> .....	8
<b>4</b>	<b>Brief Description and Characteristics</b> .....	8
<b>5</b>	<b>First Usage - Quick Start</b>	
5.1	Connectors and Front Panel .....	9
5.2	Quick Start .....	10
<b>6</b>	<b>Accessories</b> .....	10
<b>7</b>	<b>Warranty</b> .....	11
<b>8</b>	<b>Appendix</b> .....	11

▶ **Installation and Operation - Windows**

<b>9</b>	<b>Hardware Installation</b> .....	16
<b>10</b>	<b>Driver and Firmware</b>	
10.1	Driver Installation .....	16
10.2	Driver Update .....	17
10.3	De-installing the Drivers .....	17
10.4	Firmware Update.....	17
<b>11</b>	<b>Configuring the Fireface</b>	
11.1	Settings Dialog – General .....	18
11.2	Settings Dialog – Pitch .....	20
11.3	Settings Dialog – Analog .....	21
11.4	Clock Modes - Synchronization.....	22
11.5	Limit Bandwidth .....	23
<b>12</b>	<b>Operation and Usage</b>	
12.1	Playback.....	24
12.2	DVD Playback (AC-3 / DTS) .....	25
12.3	Notes on WDM .....	26
12.4	Channel Count under WDM .....	26
12.5	Multi-client Operation .....	27
12.6	Digital Recording .....	28
12.7	Analog Recording.....	28
<b>13</b>	<b>Operation under ASIO</b>	
13.1	General .....	29
13.2	Channel Count under ASIO .....	29
13.3	Known Problems .....	30
<b>14</b>	<b>Using more than one Fireface</b> .....	30
<b>15</b>	<b>DIGICheck Windows</b> .....	31
<b>16</b>	<b>Hotline – Troubleshooting</b> .....	32

▶ **Installation and Operation - Mac OS X**

<b>17</b>	<b>Hardware Installation</b> .....	34
<b>18</b>	<b>Driver and Firmware</b>	
18.1	Driver Installation .....	34
18.2	Driver Update .....	35
18.3	Firmware Update.....	35

---

<b>19</b>	<b>Configuring the Fireface</b>	
19.1	Settings Dialog – General	36
19.2	Clock Modes - Synchronization	39
19.3	Limit Bandwidth	40
<b>20</b>	<b>Mac OS X FAQ</b>	
20.1	Round about Driver Installation	41
20.2	Repairing Disk Permissions	41
20.3	MIDI doesn't work	41
20.4	Various Information	41
20.5	Supported Sample Rates	42
20.6	Channel Count under Core Audio	42
20.7	FireWire Compatibility	42
<b>21</b>	<b>Using more than one Fireface</b>	43
<b>22</b>	<b>DIGICheck Mac</b>	43
<b>23</b>	<b>Hotline – Troubleshooting</b>	44

▶ **Stand-Alone Operation, Connections and TotalMix**

<b>24</b>	<b>Stand-alone Operation</b>	
24.1	10-channel AD/DA-Converter	46
24.2	4-channel Mic Preamp	46
24.3	Monitor Mixer	46
24.4	Digital Format Converter	46
24.5	Analog/digital Routing Matrix	46
<b>25</b>	<b>Analog Inputs</b>	
25.1	Line Rear	47
25.2	Microphone / Line Front	47
25.3	Instrument	48
<b>26</b>	<b>Analog Outputs</b>	
26.1	Line	49
26.2	Phones	49
<b>27</b>	<b>Digital Connections</b>	
27.1	ADAT	50
27.2	SPDIF	50
27.3	MIDI	51
<b>28</b>	<b>Word Clock</b>	
28.1	Word Clock Input and Output	52
28.2	Technical Description and Background	53
28.3	Cables and Termination	54
28.4	General Operation	54
<b>29</b>	<b>TotalMix: Routing and Monitoring</b>	
29.1	Overview	55
29.2	The User Interface	57
29.3	Elements of a Channel	58
29.4	Tour de TotalMix	58
29.5	Submix View	60
29.6	Mute and Solo	60
29.7	Quick Access Panel	61
29.8	Presets	61
29.9	Monitor Panel	63
29.10	Preferences	63
29.11	Editing the Names	64
29.12	Hotkeys	65
29.13	Menu Options	66
29.14	Fader Groups	66
29.15	Level Meter	67

---

<b>30</b>	<b>TotalMix: The Matrix</b>	
30.1	Overview .....	68
30.2	Elements of the Matrix View .....	68
30.3	Usage .....	68
30.4	Advantages of the Matrix .....	69
<b>31</b>	<b>TotalMix Super-Features</b>	
31.1	ASIO Direct Monitoring (Windows only) .....	69
31.2	Selection and Group based Operation .....	70
31.3	Copy Routings to other Channels .....	70
31.4	Delete Routings .....	70
31.5	Recording a Subgroup (Loopback) .....	71
31.6	Using external Effects Devices .....	72
31.7	MS Processing .....	73
<b>32</b>	<b>MIDI Remote Control</b>	
32.1	Overview .....	74
32.2	Mapping .....	74
32.3	Setup .....	75
32.4	Operation .....	75
32.5	MIDI Control .....	76
32.6	Loopback Detection .....	77
32.7	Stand-Alone MIDI Control .....	78

► **Technical Reference**

<b>33</b>	<b>Tech Info</b> .....	82
<b>34</b>	<b>Technical Specifications</b>	
36.1	Analog .....	83
36.2	MIDI .....	84
36.3	Digital .....	84
36.4	Digital Inputs .....	85
36.5	Digital Outputs .....	86
36.6	General .....	86
<b>35</b>	<b>Technical Background</b>	
35.1	Lock and SyncCheck .....	87
35.2	Latency and Monitoring .....	88
35.3	FireWire Audio .....	89
35.4	Number of Channels and Bus Load .....	90
35.5	DS – Double Speed .....	91
35.6	QS – Quad Speed .....	91
35.7	AES/EBU – SPDIF .....	92
35.8	Noise Level in DS / QS Mode .....	93
35.9	SteadyClock .....	93
<b>36</b>	<b>Diagrams</b>	
36.1	Block Diagram Fireface .....	94
36.2	Connector Pinouts .....	95

---

## Important Safety Instructions



### **ATTENTION! Do not open chassis – risk of electric shock**

The unit has non-isolated live parts inside. No user serviceable parts inside. Refer service to qualified service personnel.



### **Mains**

- The device must be earthed – never use it without proper grounding
- Do not use defective power cords
- Operation of the device is limited to the manual
- Use same type of fuse only



To reduce the risk of fire or electric shock do not expose this device to rain or moisture. Prevent moisture and water from entering the device. Never leave a pot with liquid on top of the device. Do not use this product near water, i. e. swimming pool, bathtub or wet basement. Danger of condensation inside – don't turn on before the device has reached room temperature.



### **Installation**

Surface may become hot during operation – ensure sufficient ventilation. Avoid direct sun light and do not place it near other sources of heat, like radiators or stoves. When mounting in a rack, leave some space between this device and others for ventilation.



Unauthorized servicing/repair voids warranty. Only use accessories specified by the manufacturer.



Read the manual completely. It includes all information necessary to use and operate this device.



---

## User's Guide



# Fireface 800

▶ **General**

---

## 1. Introduction

Thank you for choosing the Fireface 800. This unique audio system is capable of transferring analog and digital audio data directly to a computer from practically any device. The latest Plug and Play technology guarantees a simple installation, even for the inexperienced user. The numerous unique features and well thought-out configuration dialog puts the Fireface 800 at the very top of the range of computer-based audio interfaces.

The package contains drivers for Windows XP/Vista/7/8 and Mac OS X x86 (Intel).

Our high-performance philosophy guarantees maximum system performance by executing as many functions as possible not in the driver (i.e. the CPU), but directly within the audio hardware.

## 2. Package Contents

Please check that your Fireface 800 package contains each of the following:

- RME Driver CD
- Cable IEEE1394a (FW400), 4 m (13 ft)
- Power cord
- Manual
- 1 optical cable (TOSLINK), 2 m (6.6 ft)

## 3. System Requirements

- Windows XP or higher, Mac OS X Intel (10.6 or higher)
- 1 OHCI compatible FireWire Port 400 (1394a) or 800 (1394b)

## 4. Brief Description and Characteristics

- Enhanced Mixed Mode: Analog, ADAT and SPDIF I/O simultaneously usable
- 8 buffer sizes/latencies available: 1.0 / 1.5 / 2.1 / 3 / 6 / 12 / 17 / 23 ms
- All settings can be changed in real-time
- 8 channels 96 kHz/24 bit Record/Playback via ADAT optical (S/MUX)
- Clock modes slave and master
- Automatic and intelligent master/slave clock control
- Unsurpassed Bitclock PLL (audio synchronization) in ADAT mode
- Word clock input and output
- TotalMix for latency-free submixes and perfect ASIO Direct Monitoring
- TotalMix: 1568 channel mixer with 42 bit internal resolution
- SyncAlign guarantees sample aligned and never swapping channels
- SyncCheck tests and reports the synchronization status of input signals
- 1 x MIDI I/O, 16 channels high-speed MIDI
- 1 x Hi-power headphone output
- DIGICheck DSP: Level meter in hardware, peak- and RMS calculation
- Optional Time Code module (TCO) for external Video-/SMPTE synchronization



## 5. First Usage – Quick Start

### 5.1 Connectors and Front Panel

The front of the Fireface 800 features an instrument input, microphone inputs and line inputs with gain pots, a stereo headphone output with volume pot, and several status LEDs.

**MIDI/I** indicates MIDI data received by the MIDI input.

**MIDI/O** indicates MIDI data sent to the MIDI output.

The **Digital State LEDs** (WC, SPDIF, ADAT, TCO) indicate a valid input signal separately for each digital input. Additionally, RME's exclusive *SyncCheck* indicates if one of these inputs is locked, but not synchronous to the others, in which case the LED will flash. See also chapter 11.4/19.3, Clock Modes - Synchronization.



The red **HOST** LED lights up when the Fireface 800 has been switched on, signalling the presence of operating voltage. At the same time it operates as error LED, in case the FireWire connection hasn't been initialised yet, or has been interrupted (error, cable not connected etc.).

**Phones** are low impedance line outputs of highest quality. They provide a sufficient and undistorted volume when used with headphones.

The rear panel of the Fireface 800 features eight analog inputs and outputs, the power socket, and all digital inputs and outputs:



**ADAT1 I/O** (TOSLINK)

**ADAT2 I/O** (TOSLINK): Can also be used as optical SPDIF input and output, if set up accordingly in the Settings dialog. The Settings dialog is started by clicking on the fire symbol in the Task Bar's system tray.

**SPDIF I/O** coaxial (RCA): Fully AES/EBU compatible by transformer-coupling and level adjustment. The Fireface 800 accepts the commonly used digital audio formats, SPDIF as well as AES/EBU.

**Word Clock I/O** (BNC): A push switch activates internal termination (75 Ohms). When termination is activate the yellow LED besides the switch lights up.

**IEC receptacle** for mains power connection. The specially developed, internal hi-performance switch mode power supply makes the Fireface operate in the range of 100V to 240V AC. It is short-circuit-proof, has an integrated line-filter, is fully regulated against voltage fluctuations, and suppresses mains interference.

---

## 5.2 Quick Start

After the driver installation (chapter 10 / 19) connect the TRS-jacks or the XLR connectors with the analog signal source. The input sensitivity of the rear inputs can be changed in the Settings dialog (Input Level), assuring the highest signal to noise ratio will be achieved. Try to achieve an optimum input level by adjusting the source itself. Raise the source's output level until the peak level meters in TotalMix reach about  $-3$  dB.

The analog line inputs of the Fireface 800 can be used with  $+4$  dBu and  $-10$  dBV signals. The electronic input stage can handle balanced (XLR, TRS jacks) and unbalanced (TS jacks) input signals correctly.

The front's inputs signal level can be optimized using the Fireface's Gain pots. A Signal LED and a Clip LED help to find the correct level adjustment.

The Fireface's digital outputs provide SPDIF (AES/EBU compatible) and ADAT optical signals at the corresponding ports.

On the analog playback side (the DA side), a coarse adjustment of the analog output level at the rear jacks is available in the Settings dialog (Output Level).

The output signal of channels 9/10 is available on the front. Their output level can be set using the VOL pot. This output is a very low impedance type, which can also be used to connect headphones.

The function *Store in Flash Memory* (Settings dialog) and *Flash current mixer state* (TotalMix) allow to store the current settings into the Fireface 800. The unit then remembers all settings, and loads these automatically when switched on. With this, the Fireface 800 can be used stand-alone after setting it up accordingly, replacing lots of dedicated devices (see chapter 24).

## 6. Accessories

RME offers several optional components for the Fireface 400:

Part Number	Description
-------------	-------------

Standard FireWire 400 cable, both sides 6-pin male:

FWK660100BL	FireWire cable IEEE1394a 6M/6M, 1 m (3.3 ft)
FWK660300BL	FireWire cable IEEE1394a 6M/6M, 3 m (9.9 ft)
FWK660400BL	FireWire cable IEEE1394a 6M/6M, 4 m (13 ft)

FireWire 400 cable, 4-pin male to 6-pin male (4-pin sockets are found on most laptops):

FWK460100BL	FireWire cable IEEE1394a 4M/6M, 1 m (3.3 ft)
FWK460300BL	FireWire cable IEEE1394a 4M/6M, 3 m (9.9 ft)
FWK460400BL	FireWire cable IEEE1394a 4M/6M, 4 m (13 ft)

Note: Cable longer than 15 ft (4.5m) is not specified for FireWire.

---

Optical cable for SPDIF and ADAT operation:

OK0050	Optical cable, TOSLINK, 0.5 m (1.6 ft)
OK0100	Optical cable, TOSLINK, 1 m (3.3 ft)
OK0200	Optical cable, TOSLINK, 2 m (6.6 ft)
OK0300	Optical cable, TOSLINK, 3 m (9.9 ft)
OK0500	Optical cable, TOSLINK, 5 m (16.4 ft)
OK1000	Optical cable, TOSLINK, 10 m (33 ft)

Time Code Option to be inserted in the rear slot, adding LTC and Video synchronization inputs to the Fireface.

TCOFF                      Time Code Option Fireface

## 7. Warranty

Each individual Fireface 800 undergoes comprehensive quality control and a complete test at IMM before shipping. The usage of high grade components should guarantee a long and trouble-free operation of the unit.

If you suspect that your product is faulty, please contact your local retailer.

Audio AG grants a limited manufacturer warranty of 6 months from the day of invoice showing the date of sale. The length of the warranty period is different per country. Please contact your local distributor for extended warranty information and service. Note that each country may have regional specific warranty implications.

In any case warranty does not cover damage caused by improper installation or maltreatment - replacement or repair in such cases can only be carried out at the owner's expense.

No warranty service is provided when the product is not returned to the local distributor in the region where the product had been originally shipped.

Audio AG does not accept claims for damages of any kind, especially consequential damage. Liability is limited to the value of the Fireface 800. The general terms of business drawn up by Audio AG apply at all times.

## 8. Appendix

RME news, driver updates and further product information are available on our website:

<http://www.rme-audio.com>

Distributor: Audio AG, Am Pfanderling 60, D-85778 Haimhausen, Tel.: (49) 08133 / 918170

Manufacturer:  
IMM Elektronik GmbH, Leipziger Strasse 32, D-09648 Mittweida

---

## Trademarks

All trademarks, registered or otherwise, are the property of their respective owners. RME, DIGICheck and Hammerfall are registered trademarks of RME Intelligent Audio Solutions. DIGI96, SyncAlign, ZLM, SyncCheck, TMS, TotalMix and Fireface are trademarks of RME Intelligent Audio Solutions. Alesis and ADAT are registered trademarks of Alesis Corp. ADAT optical is a trademark of Alesis Corp. Microsoft, Windows, Windows 2000, Windows XP, Windows Vista and Windows 7 are registered trademarks or trademarks of Microsoft Corp. Steinberg, Cubase and VST are registered trademarks of Steinberg Media Technologies GmbH. ASIO is a trademark of Steinberg Media Technologies GmbH. FireWire, the FireWire symbol and the FireWire logo are trademarks of Apple Computer, Inc.

Copyright © Matthias Carstens, 08/2012. Version 3.2  
Current driver version: Windows: 3.068, Mac OS X: 3.09  
Firmware 2.77

Although the contents of this User's Guide have been thoroughly checked for errors, RME can not guarantee that it is correct throughout. RME does not accept responsibility for any misleading or incorrect information within this guide. Lending or copying any part of the guide or the RME Driver CD, or any commercial exploitation of these media without express written permission from RME Intelligent Audio Solutions is prohibited. RME reserves the right to change specifications at any time without notice.

---

## CE / FCC Compliance

### CE

This device has been tested and found to comply with the limits of the European Council Directive on the approximation of the laws of the member states relating to electromagnetic compatibility according to RL2004/108/EG, and European Low Voltage Directive RL2006/95/EG.

### FCC

This equipment has been tested and found to comply with the limits for a Class B digital device, pursuant to Part 15 of the FCC Rules. These limits are designed to provide reasonable protection against harmful interference in a residential installation. This equipment generates, uses, and can radiate radio frequency energy and, if not installed and used in accordance with the instructions, may cause harmful interference to radio communications. However, there is no guarantee that interference will not occur in a particular installation. If this equipment does cause harmful interference to radio or television reception, which can be determined by turning the equipment off and on, the user is encouraged to try to correct the interference by one or more of the following measures:

- Reorient or relocate the receiving antenna.
- Increase the separation between the equipment and receiver.
- Connect the equipment into an outlet on a circuit different from that to which the receiver is connected.
- Consult the dealer or an experienced radio/TV technician for help.

### RoHS

This product has been soldered lead-free and fulfils the requirements of the RoHS directive.

### ISO 9001

This product has been manufactured under ISO 9001 quality management. The manufacturer, IMM Elektronik GmbH, is also certified for ISO 14001 (Environment) and ISO 13485 (medical devices).

## Note on Disposal

According to the guide line RL2002/96/EG (WEEE – Directive on Waste Electrical and Electronic Equipment), valid for all european countries, this product has to be recycled at the end of its lifetime.

In case a disposal of electronic waste is not possible, the recycling can also be done by IMM Elektronik GmbH, the manufacturer of the Fireface 800.

For this the device has to be sent **free to the door** to:

IMM Elektronik GmbH  
Leipziger Straße 32  
D-09648 Mittweida  
Germany



Shipments not prepaid will be rejected and returned on the original sender's costs.



---

## User's Guide



# Fireface 800

▶ **Installation and Operation - Windows**

---

## 9. Hardware Installation

### Desktop Computer

- Use the power cord to connect the Fireface with any suitable power outlet.
- Connect computer and Fireface using the supplied 6-pin FireWire cable (IEEE1394a). In case your computer does not have any FireWire port, PCI and PCI Express cards with FireWire ports are available at your local computer shop.
- Power on the computer. Switch on the Fireface when Windows shows the desktop.

### Notebook

- Use the power cord to connect the Fireface with any suitable power outlet.
- Connect computer and Fireface using the supplied 6-pin FireWire cable (IEEE1394a). In case your notebook does not have any FireWire port, CardBus and ExpressCard cards can be used to add them. In case your notebook does not have a 6-pin jack, or did not include a 6-pin to 4-pin adapter: such adapters are available in your local computer store.
- Power-on the notebook. Switch on the Fireface when Windows shows the desktop.

## 10. Driver and Firmware

### 10.1 Driver Installation

After the Fireface has been switched on, (see 9. Hardware Installation) the green arrow symbol appears in the task bar (dialog *Remove hardware*) because Windows has detected an external hardware.

Insert the RME Driver CD into your CD-ROM drive, and follow further instructions which appear on your computer screen. The driver files are located in the directory **\Fireface\_FW** on the RME Driver CD. Windows now installs the driver of the Fireface 800 and registers it as a new audio device in the system.

After a reboot, the symbols of mixer and Settings dialog will appear in the task bar. The red Host error LED extinguishes.



In **Windows 7** Microsoft removed the automatic start of the Driver Software Update dialog. Therefore this dialog has to be started manually after the failed driver installation. Hit the Win key, type 'Device Manager', start the Device Manager by selecting it from the list and hit Enter.

The device is shown with a yellow warning symbol. Usually it is already found in the correct category, Sound, Video and Game Controller (Plug & Play detects a multimedia device). Right click on the device and select 'Update Driver Software' from the context menu.

The dialog *Update Driver Software* appears. Now follow the instructions given below.



---

Possible reasons why a Fireface is not found automatically:

- The FireWire port is not active in the system (drivers of the FireWire PCI or CardBus card have not been installed)
- The FireWire cable is not, or not correctly inserted into the socket
- No power. After switching the Fireface on, at least the red Host error LED has to be lit.

## 10.2 Driver Update

When facing problems with the automatic driver update, the user-driven way of driver installation will work.

Under *>Control Panel /System /Device Manager /Sound, Video and Game Controllers /RME Fireface 800 /Properties /Driver<* you'll find the 'Update Driver' button.

**XP:** Select '**Install from a list or specific location (advanced)**', click '**Next**', select '**Don't search I will choose the driver to install**', click '**Next**', then '**Have Disk**'. Now point to the driver update's directory.

**Vista/7:** Select '**Browse my computer for driver software**', then '**Let me pick from a list of device drivers from my computer**', then '**Have Disk**'. Now point to the driver update's directory.

This method also allows for the installation of older drivers than the currently installed ones.

## 10.3 De-installing the Drivers

A de-installation of the Fireface's driver files is not necessary – and not supported by Windows anyway. Thanks to full Plug & Play support, the driver files will not be loaded after the hardware has been removed. If desired these files can then be deleted manually.

Unfortunately Windows Plug & Play methods do not cover the additional autorun entries of TotalMix, the Settings dialog, and the registration of the ASIO driver. These entries can be removed from the registry by a software de-installation request. This request can be found (like all de-installation entries) in *Control Panel, Software*. Click on the entry 'RME Fireface'.

## 10.4 Firmware Update

The Flash Update Tool updates the firmware of the Fireface 800 to the latest version. It requires an already installed driver.

Start the program **fireface\_fut.exe**. The Flash Update Tool displays the current revision of the Fireface's firmware, and whether it needs an update or not. If so, then simply press the 'Update' button. A progress bar will indicate when the flash process is finished (Verify Ok).

If more than one Fireface is installed, all units can be flashed by changing to the next tab and repeating the process.

After the update the unit needs to be reset. This is done by powering down the Fireface for a few seconds. Attention: the Fireface should not be switched off for less than 5 seconds, because Windows completely unloads the driver, which takes some time to finish.

A reboot of the computer is not necessary.

When the update fails (status: failure), the unit's second BIOS will be used from the next cold boot on (Secure BIOS Technology). Therefore the unit stays fully functional. The flash process should then be tried again on a different computer.

## 11. Configuring the Fireface

### 11.1 Settings Dialog - General

Configuration of the Fireface 800 is done via its own settings dialog. The panel 'Settings' can be opened:

- by clicking on the fire symbol in the Task Bar's system tray

The mixer of the Fireface 800 (TotalMix) can be opened:



- by clicking on the mixer icon in the Task Bar's system tray

The hardware of the Fireface 800 offers a number of helpful, well thought-of practical functions and options which affect how the card operates - it can be configured to suit many different requirements. The following is available in the 'Settings' dialog:

- Input selection
- Level of analog I/Os
- Configuration of digital I/Os
- Synchronization behaviour
- State of input and output
- Current sample rate
- Latency

Any changes made in the Settings dialog are applied immediately - confirmation (e.g. by clicking on OK or exiting the dialog) is not required.

However, settings should not be changed during playback or record if it can be avoided, as this can cause unwanted noises.

Also, please note that even in 'Stop' mode, several programs keep the recording and playback devices open, which means that any new settings might not be applied immediately.

The status display at the bottom of the dialog box gives precise information about the current status of the system, and the status of all digital input signals.

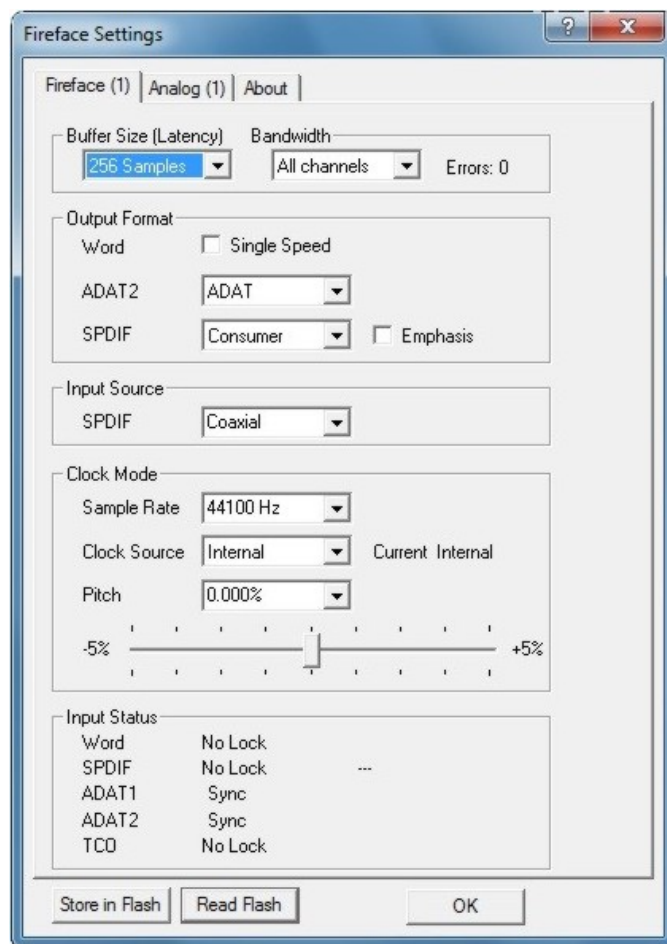

The tab **About** includes information about the current driver and firmware version.

---

## Buffer Size

The setting *Buffer Size* determines the latency between incoming and outgoing ASIO and WDM data, as well as affecting system stability (see chapter 13/14).

## Bandwidth

Allows to reduce the amount of bandwidth used on the FireWire bus. See chapter 11.5.

*All channels* (default) activates all 28 input and output channels.

*Analog + SPDIF + ADAT1* disables channels 21–28 (ADAT2).

*Analog + SPDIF* activates all 10 analog channels plus SPDIF.

*Analog 1-8* activates only the first eight analog channels.

**Errors** does not refer to buffer errors, but FireWire transmission errors. The display will be reset on any start of a playback/record. More information can be found in chapter 35.3.

## Output Format Word

The word clock output signal usually equals the current sample rate. Selecting *Single Speed* causes the output signal to always stay within the range of 32 kHz to 48 kHz. So at 96 kHz and 192 kHz sample rate, the output word clock is 48 kHz.

## ADAT2

This optical TOSLINK output can operate as ADAT or SPDIF output.

## SPDIF

The SPDIF output can have the Channel Status Consumer or Professional and Emphasis indication. For further details please refer to chapter 27.2.

## Input Source

### SPDIF

Defines the input for the SPDIF signal. 'Coaxial' relates to the RCA socket, 'ADAT2' to the second optical TOSLINK input.

## Clock Mode

### Sample Rate

Sets the currently used sample rate. Offers a central and comfortable way of configuring the sample rate of all WDM devices to the same value, as since Vista this is no longer supported to be done by the audio program. However, an ASIO program can still set the sample rate by itself.

At ongoing record/playback the selection is greyed out, so no change is possible.

## Clock Source

The unit can be configured to use its own clock (Internal = Master), or one of the input signals (Word, Optical, SPDIF coax., TCO). If the selected source isn't available, the unit will change to the next available one (AutoSync). If none is available then the internal clock is used. The current clock source is displayed to the right.

## Pitch

More information on Pitch is available in chapter 11.2.

## Input Status

Indicates for each input (Word, optical, SPDIF coax, TCO) whether there is a valid signal (Lock, No Lock), or if there is a valid *and* synchronous signal (Sync). The second row shows the sample frequency measured by the hardware. In *Clock Mode* the clock reference is shown (Current...). See also chapter 35.1.

---

### Store in Flash

A click on this button transmits all current settings into the flash memory of the Fireface. Those settings then become active directly after power-on, and also in stand-alone operation.

### Read Flash

A click on this button causes all settings to change to the ones stored in the flash memory of the Fireface.

## 11.2 Settings Dialog - Pitch

Usually soundcards and audio interfaces generate their internal clock (master mode) by a quartz. Therefore the internal clock can be set to 44.1 kHz or 48 kHz, but not to a value in between. SteadyClock, RME's sensational Low Jitter Clock System, is based on a Direct Digital Synthesizer (DDS). This superior circuitry can generate nearly any frequency with highest precision.

DDS has been implemented into the Fireface with regard to the needs of professional video applications, as well as to maximum flexibility. The section Pitch includes both a list of typical video frequencies (so called pull up/pull down at 0.1% and 4%) and a fader to freely change the basic sample rate in steps of 1 Hz (!) over a range of +/- 5%.

 *The Pitch function requires the Fireface to be in clock mode Master! The frequency setting will only be applied to this one specific Fireface!*

 *Changing the sample rate during record/playback often results in a loss of audio, or brings up warning messages of the audio software. Therefore the desired sample rate should be set at least coarsely before starting the software.*

### Coarse

Coarse modification in steps of 50 Hz is done by clicking with the mouse to the left and right of the fader knob.

### Fine

Fine modification in steps of 1 Hz is done by using the left/right cursor keys.

### Reset

Ctrl key plus left mouse click.

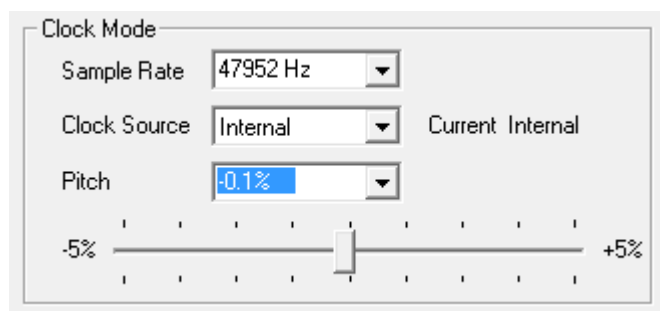

### Application examples

Pitch allows for a simultaneous change of speed and tune during record and playback. From alignment to other sources up to creative effects – everything is possible.

Pitch enables you to intentionally de-tune the complete DAW. This way, the DAW can match instruments which have a wrong or unchangeable tuning.

Pitch allows for the change of the sample rate of all WDM devices at the same time. Since Vista this is no longer possible via the audio program, thus requires a manual reconfiguration of all WDM devices. Changing the sample rate from the Settings dialog solves this problem. As the change within the system requires some time, record/playback should not be started immediately, but not before 5 seconds after a change.

---

## 11.3 Settings Dialog – Analog

### Inputs

Input selection for the channels 1, 7 and 8. Channel 1 can be the front instrument input, or the rear TRS jack, or both simultaneously. Channel 7/8 can be the front microphone input, or the rear TRS jack, or both simultaneously.

### Level

#### Line In

Defines the reference level of the rear analog inputs 5-8.

#### Line Out

Defines the reference level of the rear analog outputs 1-6.

### Phantom Power

Phantom power (48V) can be selected for each microphone input separately.

### Instrument Options

*Drive* activates 25 dB additional gain for maximum sustain and brute distortion.

*Limiter* activates a soft-limiter with a threshold of  $-10$  dBFS. Note: The Limiter can only be switched off with input selection *Front*.

*Speaker Emulation* removes low frequency noise and cuts off higher frequencies.

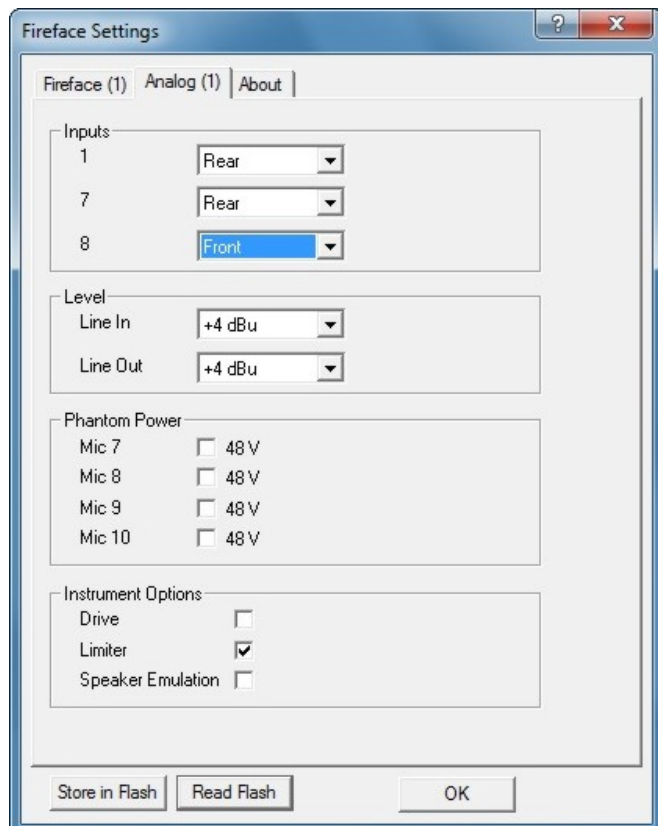

---

## 11.4 Clock Modes - Synchronization

In the digital world, all devices must be either Master (clock source) or Slave (clock receiver). Whenever several devices are linked within a system, there must always be a single master clock.

 *A digital system can only have one master! If the Fireface's clock mode is set to 'Master', all other devices must be set to 'Slave'.*

The Fireface 800 utilizes a very user-friendly, intelligent clock control, called **AutoSync**. In AutoSync mode, the system constantly scans the digital input for a valid signal. If any valid signal is found, the Fireface switches from the internal quartz (*Clock Mode – Current Internal*) to a clock extracted from the input signal (*Clock Mode – Current ADAT, SPDIF or Word*). The difference to a usual slave mode is that whenever the clock reference fails, the system will automatically use its internal clock and operate in clock mode Master.

AutoSync guarantees that record and record-while-play will always work correctly. In certain cases however, e.g. when the inputs and outputs of a DAT machine are connected directly to the UCX, AutoSync may cause feedback in the digital carrier, so synchronization breaks down. To solve this problem switch the Fireface clock mode to Master (Clock Source – Internal).

The Fireface's ADAT optical and SPDIF input operate simultaneously. Because there is no input selector however, the unit has to be told which one of the signals is the sync reference (a digital device can only be clocked from a *single* source). By selecting a Clock Source a preferred input is defined. As long as the unit sees a valid signal there, it will be used as the sync source.

In some situations changing the clock mode can not be avoided. Example: An ADAT recorder is connected to the ADAT input (ADAT immediately becomes the AutoSync source) and a CD player is connected to the SPDIF input. Try recording a few samples from the CD and you will be disappointed - few CD players can be synchronized. The samples will inevitably be corrupted, because the signal from the CD player is read with the clock from the ADAT. In this case the Clock Source should be temporarily set to *SPDIF*.

RME's exclusive **SyncCheck** technology (first implemented in the Hammerfall) enables an easy to use check and display of the current clock status. *SyncCheck* indicates whether there is a valid signal (Lock, No Lock) for each input (Word Clock, ADAT, SPDIF), or if there is a valid *and* synchronous signal (Sync). In the field *Clock Mode* the clock reference is shown. See chapter 37.1.

Under WDM the Fireface will (has to) set the sample rate. Therefore the error shown to the right can occur. A stable signal with a sample rate of 32 kHz is detected at the ADAT input (Sync), but Windows audio had been set to 44100 Hz before. The red color of the text label signals the error condition, and prompts the user to set 32000 Hz manually as sample rate. Under ASIO the audio software sets the sample rate, so that such an error can not happen. If the input sample rate is different then there will be no Sync indication.

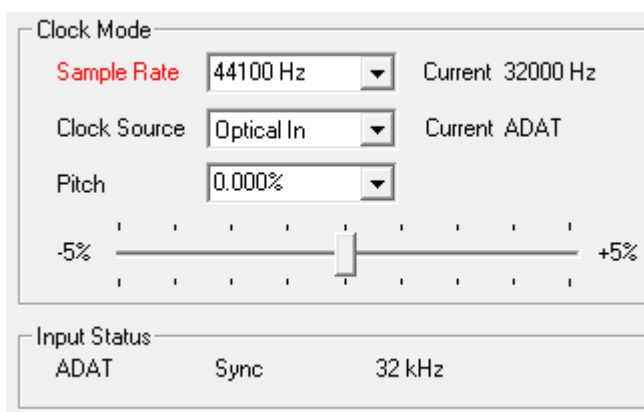

In practice, SyncCheck provides the user with an easy way of checking whether all digital devices connected to the system are properly configured. With SyncCheck, finally anyone can master this common source of error, previously one of the most complex issues in the digital studio world.

---

## 11.5 Limit Bandwidth

This option allows to reduce the amount of bandwidth used on the FireWire bus. A typical example is the use of the Fireface with a laptop. Only in rare cases both ADAT ports are needed, in many cases even both stay unused. The option *Analog+SPDIF* will reduce the amount of constantly (!) transferred data from around 5 MByte (10 in both directions) to only 2 MByte (4 in both directions). The FireWire connection will be more stable, reliable and robust, leaving additional bandwidth for other devices. At the same time the CPU and system load is reduced, as less channels have to be processed and to be transferred. In TotalMix, the deactivated software playback channels will be replaced with empty plates. More details are found in chapter 35.4.

### Available Settings

*All channels* (default) activates all 28 input and output channels.

*Analog + SPDIF + ADAT1* disables channels 21–28 (ADAT2).

*Analog + SPDIF* activates all 10 analog channels plus SPDIF.

*Analog 1-8* activates only the first eight analog channels.

---

## 12. Operation and Usage

### 12.1 Playback

The Fireface 800 can play back audio data in supported formats only (sample rate, bit resolution). Otherwise an error message appears (for example at 22 kHz and 8 bit).

In the audio application being used, Fireface must be selected as output device. This can often be found in the *Options, Preferences* or *Settings* menus under *Playback Device, Audio Devices, Audio* etc.

We strongly recommend switching all system sounds off (via >*Control Panel /Sounds*<). Also Fireface should not be the *Preferred Device* for playback, as this could cause loss of synchronization and unwanted noises. If you feel you cannot do without system sounds, you should consider buying a cheap Blaster clone and select this as *Preferred Device* in >*Control Panel /Multimedia /Audio*< or >*Control Panel /Sound /Playback*<.

The screenshot shows a typical configuration dialog of a (stereo) wave editor. Audio data is sent to an analog or digital (ADAT / SPDIF) port, depending on which has been selected as playback device.

Increasing the number and/or size of audio buffers may prevent the audio signal from breaking up, but also increases latency i.e. output is delayed. For synchronized playback of audio and MIDI (or similar), be sure to activate the checkbox 'Get position from audio driver'.

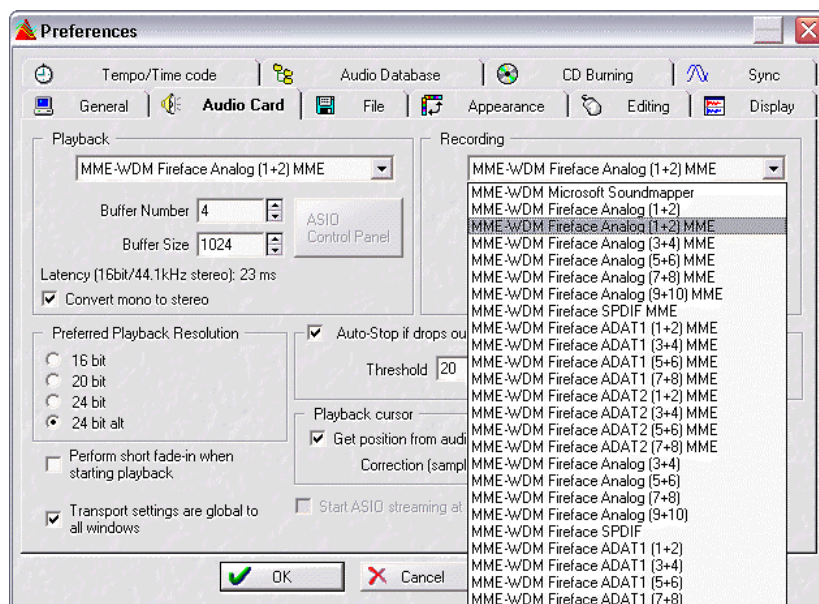

#### Note on Windows Vista/7:

Since Vista the audio application can no longer control the sample rate under WDM. Instead the user has to work himself through numerous settings, and to set the sample rate to the same value per stereo device.

Therefore the driver of the Fireface 800 includes a workaround: the sample rate can be set globally for all WDM devices within the Settings dialog, see chapter 11.1.



---

## 12.2 DVD-Playback (AC-3/DTS)

### AC-3 / DTS

When using popular DVD software players like *WinDVD* and *PowerDVD*, their audio data stream can be sent to any AC-3/DTS capable receiver using the Fireface's SPDIF output. For this to work, the WDM SPDIF device of the Fireface has to be selected in *>Control Panel/ Sounds and Multimedia/ Audio<* or *>Control Panel/ Sound/Playback<*. Also check 'use preferred device only'.

The DVD software's audio properties now show the options 'SPDIF Out' or similar. When selecting it, the software will transfer the non-decoded digital multichannel data stream to the Fireface.

Note: This 'SPDIF' signal sounds like chopped noise at highest level. Try to avoid mixing and routing the signal to your loudspeakers, as they might get damaged.

### Multichannel

PowerDVD and WinDVD can also operate as software decoder, sending a DVD's multichannel data stream directly to the analog outputs of the Fireface. For this to work select the WDM playback device 'Loudspeaker' of the Fireface in

**XP**: *>Control Panel/ Sounds and Multimedia/ Audio<*, and check 'Use only default devices'. Additionally the loudspeaker setup, found under *>Volume/ Speaker Settings/ Advanced<* has to be changed from *Stereo* to *5.1 Surround*.

**Vista/7**: *>Control Panel/ Sound/ Playback <* as 'Standard'. Additionally the loudspeaker setup, found under *>Configuration<*, has to be changed from *Stereo* to *5.1 Surround*.

PowerDVD's and WinDVD's audio properties now list several multichannel modes. If one of these is selected, the software sends the decoded analog multichannel data to the Fireface. TotalMix can then be used to play back via any desired output channels.

The typical channel assignment for surround playback is:

- 1 - Left
- 2 - Right
- 3 - Center
- 4 - LFE (Low Frequency Effects)
- 5 - SL (Surround Left)
- 6 - SR (Surround Right)

Note 1: Selecting the Fireface to be used as system playback device is against our recommendations, as professional interfaces should not be disturbed by system events. Make sure to re-assign the selection after usage or to disable any system sounds (tab *Sounds*, scheme 'No audio').

Note 2: The DVD player will be synced backwards from the Fireface. This means when using AutoSync and/or word clock, the playback speed and pitch follows the incoming clock signal.

---

## 12.3 Notes on WDM

The driver offers a WDM streaming device per stereo pair, like **Fireface ADAT 1 (1+2)**. WDM streaming is Microsoft's current driver and audio system, directly embedded into the operating system. WDM streaming is hardly usable for professional music purposes, as all data is processed by the so called Kernel Mixer, causing a latency of at least 30 ms. Additionally, WDM can perform sample rate conversions unnoticed, cause offsets between record and playback data, block channels unintentionally and much more.

Several programs do not offer any direct device selection. Instead they use the *playback device* selected in Windows under

**XP:** <Control Panel/ Sounds and Multimedia/ Audio>

**Vista/7:** <Control Panel/ Sound/ Playback>

The program *Sonar* from Cakewalk is unique in many ways. Sonar uses the so called **WDM Kernel Streaming**, bypassing the WDM mixer, thus achieves a similar performance to ASIO.

Because of the driver's multichannel streaming ability (option Interleaved, see chapter 12.4), Sonar not only finds the stereo device mentioned above, but also the 8-channel interleaved devices, and adds the channel number at the end:

RayDAT ADAT (1+2) is the first stereo device

RayDAT ADAT (3+4) is the next stereo device

RayDAT ADAT (1+2) 3/4 are the channels 3/4 of the first 8-channel interleaved device.

It is not recommended to use these special interleaved devices. Also it is not possible to use one stereo channel twice (the basic and the interleaved device).

### Multi-Channel using WDM

The WDM Streaming device *Loudspeaker* (Analog 1+2) of the RME driver can operate as usual stereo device, or as up to 8-channel device.

An 8-channel playback using the Windows Media Player requires the speaker setup 7.1 *Surround*. Configure as follows:

**XP:** >Control Panel /Sounds and Multimedia /Audio /Volume /Speaker Settings /Advanced <

**Vista/7:** >Control Panel /Sound /Playback /Loudspeaker /Configure <

## 12.4 Channel Count under WDM

The HDSP system's ADAT optical interfaces allow to record sample rates of up to 96 kHz using a standard ADAT recorder. For this to work single-channel data is spread to two ADAT channels using the *Sample Multiplexing* technique. This reduces the number of available ADAT channels from 8 to 4 per ADAT port.

Whenever the Fireface changes into Double Speed (88.2/96 kHz) or Quad Speed mode (176.4/192 kHz) all devices no longer available vanish automatically.

<b>WDM Stereo device</b>	<b>Double Speed</b>	<b>Quad Speed</b>
Fireface Analog (1+2)	Fireface Analog (1+2)	Fireface Analog (1+2)
Fireface Analog (3+4)	Fireface Analog (3+4)	Fireface Analog (3+4)
Fireface Analog (5+6)	Fireface Analog (5+6)	Fireface Analog (5+6)
Fireface Analog (7+8)	Fireface Analog (7+8)	Fireface Analog (7+8)
Fireface Analog (9+10)	Fireface Analog (9+10)	Fireface Analog (9+10)
Fireface SPDIF	Fireface SPDIF	Fireface SPDIF
Fireface ADAT 1 (1+2)	Fireface ADAT 1 (1+2)	Fireface ADAT 1 (1+2)
Fireface ADAT 1 (3+4)	Fireface ADAT 1 (3+4)	Fireface ADAT 1 (3+4)
Fireface ADAT 1 (5+6)	Fireface ADAT 1 (5+6)	Fireface ADAT 1 (5+6)
Fireface ADAT 1 (7+8)	Fireface ADAT 1 (7+8)	Fireface ADAT 1 (7+8)
Fireface ADAT 2 (1+2)	Fireface ADAT 2 (1+2)	Fireface ADAT 2 (1+2)
Fireface ADAT 2 (3+4)	Fireface ADAT 2 (3+4)	Fireface ADAT 2 (3+4)
Fireface ADAT 2 (5+6)	Fireface ADAT 2 (5+6)	Fireface ADAT 2 (5+6)
Fireface ADAT 2 (7+8)	Fireface ADAT 2 (7+8)	Fireface ADAT 2 (7+8)

Note: Under Vista/7 the analog outputs 1/2 show up as *Loudspeaker*.

## 12.5 Multi-client Operation

RME audio interfaces support multi-client operation. Several programs can be used at the same time. The formats ASIO and WDM can even be used on the same playback channels simultaneously. As WDM uses a real-time sample rate conversion (ASIO does not), all active ASIO software has to use the same sample rate.

However, a better overview is maintained by using the channels exclusively. This is no limitation at all, because TotalMix allows for any output routing, and therefore a playback of multiple software on the same hardware outputs.

Inputs can be used from an unlimited number of WDM and ASIO software at the same time, as the driver simply sends the data to all applications simultaneously.

RME's sophisticated tool *DIGICheck* is an exception to this rule. It operates like an ASIO host, using a special technique to access playback channels directly. Therefore DIGICheck is able to analyse and display playback data from any software, no matter which format it uses.

---

## 12.6 Digital Recording

Unlike analog soundcards which produce empty wave files (or noise) when no input signal is present, digital interfaces always need a valid input signal to start recording.

Taking this into account, RME added two important features to the Fireface 800: a comprehensive I/O signal status display showing sample frequency, lock and sync status in the Settings dialog, and status LEDs for each input.

The sample frequency shown in the Settings dialog (see chapter 11.1, screenshot Settings) is useful as a quick display of the current configuration (the board itself and all connected external equipment). If no sample frequency is recognized, it will read 'No Lock'.

This way, configuring any suitable audio application for digital recording is simple. After selecting the required input, Fireface UC displays the current sample frequency. This parameter can then be changed in the application's audio attributes (or similar) dialog.

It often makes sense to monitor the input signal or send it directly to the output. This can be done at zero latency using **TotalMix** (see chapter 29).

An *automated* control of real-time monitoring can be achieved by Steinberg's ASIO protocol with RME's ASIO drivers and all ASIO 2.0 compatible programs. When 'ASIO Direct Monitoring' has been switched on, the input signal is routed in real-time to the output whenever a recording is started (punch-in).

## 12.7 Analog Recording

For recordings via the analog inputs the corresponding record device has to be chosen (Fireface Analog (x+x)). Apart from the three reference levels, the Fireface has no means to change the input level. This would make no sense for the digital inputs, but also for the analog inputs one can do without it. It doesn't matter if the Fireface is operated at a mixing desk or a multichannel mic preamp, in either case the level can be controlled directly at the source to match the Fireface's sensitivity perfectly.

The input sensitivity of the frontside analog inputs can be adjusted using their Gain pots to match any external source perfectly, see chapter 27.2.

---

## 13. Operation under ASIO

### 13.1 General

Start the ASIO software and select **ASIO Fireface** as the audio I/O device.

The Fireface 800 supports *ASIO Direct Monitoring* (ADM).

The Fireface 800 MIDI I/O can be used with both MME MIDI and DirectMusic MIDI.

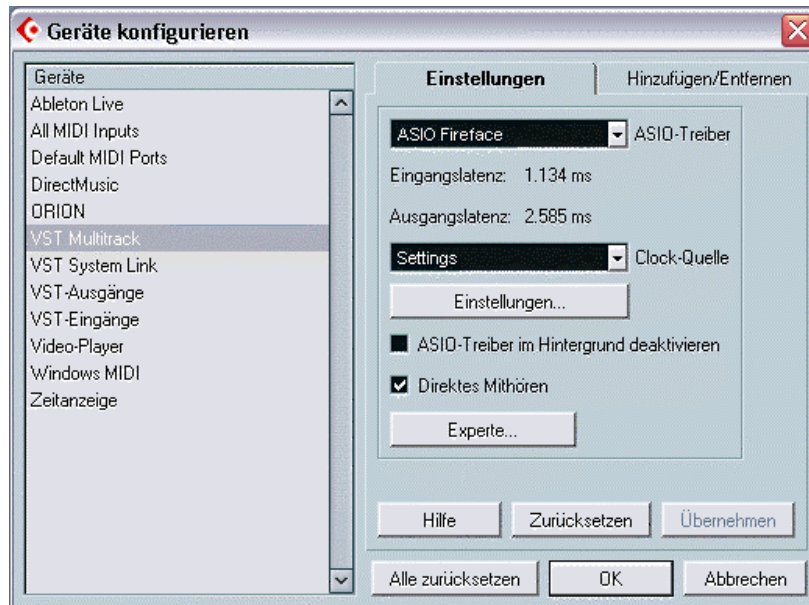

### 13.2 Channel Count under ASIO

At a sample rate of 88.2 or 96 kHz, the ADAT optical input and outputs operate in S/MUX mode, so the number of available channels per port is reduced from 8 to 4.

Note: When changing the sample rate range between Single, Double and Quad Speed the number of channels presented from the ASIO driver will change too. This may require a reset of the I/O list in the audio software.

Single Speed	Double Speed	Quad Speed
Fireface Analog 1 bis 8	Fireface Analog 1 bis 8	Fireface Analog 1 bis 8
Fireface SPDIF L / R	Fireface SPDIF L / R	Fireface SPDIF L / R
Fireface ADAT 1 bis 8	Fireface ADAT 1 bis 8	Fireface ADAT 1 bis 8
Fireface ADAT 9 bis 16	Fireface ADAT 9 bis 16	Fireface ADAT 9 bis 16

---

### 13.3 Known Problems

If a computer does not provide sufficient CPU-power and/or sufficient PCI-bus transfer rates, then drop outs, crackling and noise will appear. Raising the buffer size in the Settings dialog of the Fireface 800 helps in most cases. We also recommend to deactivate all PlugIns to verify that these are not the reason for such effects.

The above note on PCI is not an error in this manual: very often FireWire controllers are connected to the PCI bus. Therefore the same problems known from PCI audio cards can occur with FireWire audio interfaces as well. Further information is found in chapter 35.3.

Another common source of trouble is incorrect synchronization. ASIO does not support asynchronous operation, which means that the input and output signals not only have to use the same sample frequency, but also have to be in sync. All devices connected to the Fireface 800 must be properly configured for Full Duplex operation. As long as SyncCheck (in the Settings dialog) only displays *Lock* instead of *Sync*, the devices have not been set up properly!

When using more than one Fireface 800, all Firefaces have to be in sync, see chapter 14. Else a periodically repeated noise will be heard.

Fireface 800 supports *ASIO Direct Monitoring (ADM)*. Please note that not all programs support ADM completely or error-free. The most often reported problem is the wrong behaviour of panorama in a stereo channel.

In case of a drift between audio and MIDI, or in case of a fixed deviation (MIDI notes placed close before or behind the correct position), the settings in Cubase/Nuendo have to be changed. At the time of print the option 'Use System Timestamp' should be activated. The Fireface supports both MME MIDI and DirectMusic MIDI. It depends on the used application which one will work better.

## 14. Using more than one Fireface 800

The current driver supports up to three Fireface 800. All units have to be in sync, i.e. have to receive valid sync information (either via word clock or by using AutoSync and feeding synchronized signals).

- If one of the Firefaces is set to clock mode Master, all others have to be set to clock mode AutoSync, and have to be synced from the master, for example by feeding word clock. The clock modes of all units have to be set up correctly in the Fireface Settings dialog.
- If all units are fed with a synchronous clock, i.e. all units show *Sync* in their Settings dialog, all channels can be used at once. This is especially easy to handle under ASIO, as the ASIO driver presents all units as one.

When using all channels of more than one Fireface 800, a FireWire 800 interface is necessary. FireWire 400 will usually not suffice for operating more than one Fireface. When using only one Fireface 800, a FireWire 800 interface does not provide any performance advantages, especially does not help to achieve lower latency. But when a hard drive is connected to the Fireface (hub functionality), FireWire 800 will immediately increase performance and reliability.

- The cabling of FireWire 800 units is critical. In real world operation, it is not unusual that all Firefaces have to be connected directly to the 1394b ports of the computer, using cables of similar length. A long cable from the computer to the first Fireface, and a short one from the first to the second Fireface can cause problems.

More information about numbers of channels and bus load can be found in chapter 35.4.

---

The driver takes care of the numbering of all Firefaces, so that it doesn't change. The unit with the lowest serial number is always 'Fireface (1)'. Please note:

- If the Fireface (1) is switched off, Fireface (2) logically turns to the first and only Fireface. If Fireface (1) is switched on later, the numbering changes and the unit becomes Fireface (2) immediately.
- The driver has no control on the numbering of the WDM devices. Therefore it might happen that the WDM devices (2) are mapped to unit (1), especially when switching on more Firefaces during a Windows session. A reboot with all Firefaces already operational should solve this problem.

Note: TotalMix is part of the hardware of each Fireface. Up to three mixers are available, but these are separated and can't interchange data. Therefore a global mixer for all units is not possible.

## 15. DIGICheck Windows

The DIGICheck software is a unique utility developed for testing, measuring and analysing digital audio streams. Although this Windows software is fairly self-explanatory, it still includes a comprehensive online help. DIGICheck 5.5 operates as multi-client ASIO host, therefore can be used in parallel to any software, be it WDM or ASIO, with both inputs and outputs (!). The following is a short summary of the currently available functions:

- **Level Meter.** High precision 24-bit resolution, 2/10/28 channels. Application examples: Peak level measurement, RMS level measurement, over-detection, phase correlation measurement, dynamic range and signal-to-noise ratios, RMS to peak difference (loudness), long term peak measurement, input check. Oversampling mode for levels higher than 0 dBFS. Vertical and horizontal mode. Slow RMS and RLB weighting filter. Supports visualization according to the K-System.
- **Hardware Level Meter for Input, Playback and Output.** Reference Level Meter freely configurable, causing near zero CPU load, because calculated from the Fireface hardware.
- **Vector Audio Scope.** World wide unique Goniometer showing the typical afterglow of a oscilloscope-tube. Includes Correlation meter and level meter.
- **Spectral Analyser.** World wide unique 10-, 20- or 30-band display in analog bandpass-filter technology. 192 kHz-capable!
- **Totallyser.** Spectral Analyser, Level Meter and Vector Audio Scope in a single window.
- **Surround Audio Scope.** Professional Surround Level Meter with extended correlation analysis, ITU weighting and ITU summing meter.
- **ITU1770/EBU R128 Meter.** For standardized loudness measurements.
- **Bit Statistics & Noise.** Shows the true resolution of audio signals as well as errors and DC offset. Includes Signal to Noise measurement in dB and dBA, plus DC measurement.
- **Channel Status Display.** Detailed analysis and display of SPDIF and AES/EBU Channel Status data.
- **Global Record.** Long-term recording of all channels at lowest system load.
- **Completely multi-client.** Open as many measurement windows as you like, on any channels and inputs or outputs!

To install DIGICheck, go to the **\DIGICheck** directory on the RME Driver CD and run *setup.exe*. Follow the instructions prompted on the screen.

DIGICheck is constantly updated. The latest version is always available on our website [www.rme-audio.com](http://www.rme-audio.com), section **Downloads / DIGICheck**.

---

## 16. Hotline – Troubleshooting

The newest information can always be found on our website [www.rme-audio.com](http://www.rme-audio.com), section FAQ, Latest Additions.

*The input signal cannot be monitored in real-time*

- ASIO Direct Monitoring has not been enabled, and/or monitoring has been disabled globally.

*The 8 ADAT channels don't seem to work*

- The optical output ADAT2 has been switched to SPDIF. As can be seen in the block diagram, all channels and their assignments still exist, but the optical transmitter has been disconnected from ADAT2 and is now fed from the SPDIF output (channels 11/12). The ADAT2 playback devices are still usable by routing and mixing them in TotalMix to other outputs.

*Playback works, but record doesn't*

- Check that there is a valid signal at the input. If so, the current sample frequency is displayed in the Settings dialog.
- Check whether the Fireface 800 has been selected as recording device in the audio application.
- Check whether the sample frequency set in the audio application ('Recording properties' or similar) matches the input signal.
- Check that cables/devices have not been connected in a closed loop. If so, set the system's clock mode to Master.

*Crackle during record or playback*

- Increase the number and size of buffers in the 'Settings' dialog or in the application.
- Try different cables (coaxial or optical) to rule out any defects here.
- Check that cables/devices have not been connected in a closed loop. If so, set the system's clock mode to 'Master'.
- Increase the buffer size of the hard disk cache.
- Check the Settings dialog for displayed Errors.

*Driver installation and Settings dialog/TotalMix work, but a playback or record is not possible*

- While recognition and control of the device are low bandwidth applications, playback/record needs the full FireWire transmission performance. Therefore, defective FireWire cables with limited transmission bandwidth can cause such an error scheme.



---

## User's Guide



# Fireface 800

- ▶ **Mac OS X – Installation and Operation**

---

## 17. Hardware Installation

### Desktop Computer

- Use the power cord to connect the Fireface with any suitable power outlet.
- Connect computer and Fireface using the supplied 6-pin FireWire cable (IEEE1394a).
- Power on the computer, then switch on the Fireface.

### Notebook

- Use the power cord to connect the Fireface with any suitable power outlet.
- Connect computer and Fireface using the supplied 6-pin FireWire cable (IEEE1394a).
- Power on the notebook, then switch on the Fireface 800.

## 18. Driver and Firmware

### 18.1 Driver Installation

After the Fireface has been switched on (see 17. Hardware Installation) install the drivers from the RME Driver CD. The driver files are located in the folder **Fireface\_FW**. Installation works automatically by a double-click on the file **fireface.pkg**.

RME recommends downloading the latest driver version from the RME website. If done, the procedure is as follows:

A double-click onto **fireface\_x86.zip** expands the archive file to the folder **Fireface\_x86\_xxx**, which includes the driver file **fireface.pkg**. Installation works automatically by a double-click on this file.

During driver installation the programs **Fireface Settings** and **Fireface mixer** (TotalMix) will also be installed. Both programs start automatically as soon as a Fireface is detected. They stay in the dock when exited, and remove themselves automatically from the dock when the Fireface is removed.

Reboot the computer when installation is done.

Possible reasons why a Fireface is not found after driver installation:

- The FireWire port is not active in the system (drivers of the FireWire PCI or CardBus card have not been installed)
- The FireWire cable is not, or not correctly inserted into the socket
- No power. After switching the Fireface on, at least the red Host error LED has to be lit.

---

## 18.2 Driver Update

In case of a driver update it's not necessary to remove the old driver first, it will be overwritten during the installation. In case of problems the driver files can be deleted manually by dragging them to the trash bin:

```
/Applications/Fireface Mixer  
/Applications/Fireface Settings  
/System/Library/Extensions/FirefaceAudioDriver.kext  
/Users/username/Library/Preferences/Fireface Folder  
/Users/username/Library/Preferences/com.rme.FirefaceMixer.plist  
/Users/username/Library/Preferences/de.rme-audio.TotalmixFX.plist  
/Users/username/Library/Preferences/de.rme-audio.FirefaceSettings.plist  
/Library/LaunchAgents/de.rme-audio.firefaceAgent.plist
```

Under the latest Mac OS the User/Libraries folders are hidden and not visible in the Finder. To unhide them start terminal and enter:

```
"chflags nohidden ~/Library/"
```

## 18.3 Firmware Update

The Flash Update Tool updates the firmware of the Fireface 800 to the latest version. It requires an already installed driver.

Start the program **Fireface Flash**. The Flash Update Tool displays the current revision of the Fireface's firmware, and whether it needs an update or not. If so, simply press the 'Update' button. A progress bar will indicate when the flash process is finished (Verify Ok).

If more than one Fireface is installed, all units can be flashed by changing to the next tab and repeating the process.

After the update the unit needs to be reset. This is done by powering down the Fireface for a few seconds. A reboot of the computer is not necessary.

When the update fails (status: failure), the unit's second BIOS will be used from the next cold boot on (Secure BIOS Technology). Therefore the unit stays fully functional. The flash process should then be tried again on a different computer.

---

## 19. Configuring the Fireface

### 19.1 Settings Dialog - General

Configuring the Fireface is done via its own settings dialog. Start the program **Fireface Settings**. The mixer of the Fireface (TotalMix) can be configured by starting the program **Fireface Mixer**.

The Fireface's hardware offers a number of helpful, well thought-of practical functions and options which affect how the card operates - it can be configured to suit many different requirements.

The following is available in the 'Settings' dialog:

- Input selection
- Level of analog I/Os
- Configuration of digital I/Os
- Synchronization behaviour
- State of input and output
- Current sample rate

Any changes performed in the Settings dialog are applied immediately - confirmation (e.g. by exiting the dialog) is not required.

However, settings should not be changed during playback or record if it can be avoided, as this can cause unwanted noises.

Use the drop down menu **Properties For** to select the unit to be configured.

On the right of it the current firmware and driver version is shown.

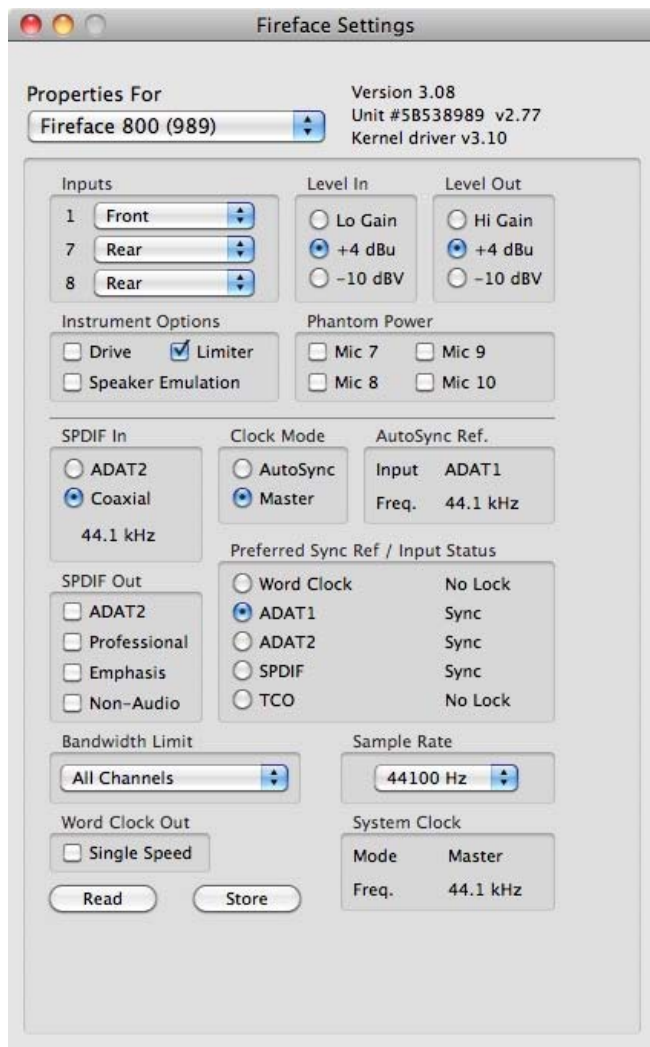

---

### **Inputs**

Input selection for the channels 1, 7 and 8. Channel 1 can be the front instrument input, or the rear TRS jack, or both simultaneously. Channel 7/8 can be the front microphone input, or the rear TRS jack, or both simultaneously.

### **Level In**

Defines the reference level for the rear analog inputs 1-8.

### **Level Out**

Defines the reference level for the rear analog outputs 1-8.

### **Instrument Options**

*Drive* activates 25 dB additional gain for maximum sustain and brute distortion.

*Limiters* activates a soft-limiter with a threshold of  $-10$  dBFS. Note: The Limiter can only be switched off with input selection *Front*.

*Speaker Emulation* removes low frequency noise and cuts off higher frequencies.

### **Phantom Power**

Phantom power (48V) can be selected for each microphone input separately.

### **SPDIF In**

Defines the input for the SPDIF signal. 'Coaxial' relates to the RCA socket, 'ADAT2' to the second optical TOSLINK input.

### **SPDIF Out**

The SPDIF output signal is constantly available at the phono plug. After selecting 'ADAT2' it is also routed to the second optical TOSLINK output. For further details about the settings 'Professional', 'Emphasis' and 'Non-Audio', please refer to chapter 27.2.

### **Clock Mode**

The unit can be configured to use its internal clock source (Master), or the clock source pre-defined via *Pref. Sync Ref* (AutoSync).

### **AutoSync Ref.**

Displays the current clock source and sample rate of the clock source.

### **Preferred Sync Ref / Input Status**

Used to pre-select the desired clock source. If the selected source isn't available, the system will change to the next available one. The current clock source and sample rate is displayed in the *AutoSync Ref* display.

The automatic clock selection checks and changes between the clock sources Word Clock, ADAT1, ADAT2, SPDIF and TCO (when using the optional TCO module).

*Input Status* indicates whether there is a valid signal (Lock, No Lock) for each input (Word clock, ADAT1, ADAT2, SPDIF), or if there is a valid *and* synchronous signal (Sync). The *AutoSync Ref* display shows the input and frequency of the current sync source.

---

**Bandwidth Limit**

Allows to reduce the amount of bandwidth used on the FireWire bus. See chapter 19.3.

*All channels* (default) activates all 28 input and output channels.

*Analog + SPDIF + ADAT1* disables channels 21–28 (ADAT2).

*Analog + SPDIF* activates all 10 analog channels plus SPDIF.

*Analog 1-8* activates only the first eight analog channels.

**Sample Rate**

This setting is a mirror of the system's own control panel to change the sample rate. It has been included for convenience.

**System Clock**

Shows the current clock state of the Fireface 800. The unit is either Master (using its own clock) or Slave (AutoSync Ref).

**Word Clock Out**

The word clock output signal usually equals the current sample rate. Selecting *Single Speed* causes the output signal to always stay within the range of 32 kHz to 48 kHz. So at 96 kHz and 192 kHz sample rate, the output word clock is 48 kHz.

**Read (Flash Memory)**

A click on this button causes all settings to change to the ones stored in the flash memory of the Fireface.

**Store (in Flash Memory)**

A click on this button transmits all current settings into the flash memory of the Fireface. Those settings then become active directly after power-on, and also in stand-alone operation.

---

## 19.2 Clock Modes - Synchronization

In the digital world, all devices must be either 'Master' (clock source) or 'Slave' synchronized to a master. Whenever several devices are linked within a system, there must always be a single master clock. The Fireface's intelligent clock control is very user-friendly, being able to switch between clock modes automatically. Selecting **AutoSync** will activate this mode.

In AutoSync mode, the system constantly scans all digital inputs for a valid signal. If any valid signal is found, the Fireface switches from the internal quartz (*System Clock* – Mode displays 'Master') to a clock extracted from the input signal (*System Clock* - Mode displays 'Slave'). The difference to a usual slave mode is that whenever the clock reference fails, the system will automatically use its internal clock and operate in 'Master' mode.

AutoSync guarantees that record and record-while-play will always work correctly. In certain cases however, e.g. when the inputs and outputs of a DAT machine are connected directly to the Fireface 800, AutoSync may cause feedback in the digital carrier, so synchronization breaks down. To remedy this, switch the Fireface's clock mode over to 'Master'.



*Remember that a digital system can only have one master! If the Fireface's clock mode is set to 'Master', all other devices must be set to 'Slave'.*

The Fireface's ADAT optical and SPDIF inputs operate simultaneously. Because there is no input selector however, the Fireface 800 has to be told which of the signals is the sync reference (a digital device can only be clocked from a *single* source). Via *Pref. Sync Ref* (preferred synchronization reference) a preferred input can be defined. As long as the card sees a valid signal there, this input will be designated as the sync source.

To cope with some situations which may arise in studio practice, defining a preferred sync reference is essential. One example: An ADAT recorder is connected to the ADAT input (ADAT immediately becomes the AutoSync source) and a CD player is connected to the SPDIF input. Try recording a few samples from the CD and you will be disappointed. Few CD players can be synchronized. The samples will inevitably be corrupted, because the signal from the CD player is read with the (wrong) clock from the ADAT i.e. out of sync. In this case, *Pref Sync Ref* should be temporarily set to SPDIF.

If several digital devices are to be used simultaneously in a system, they not only have to operate with the same sample frequency but also be synchronous with each other. This is why digital systems always need a single device defined as 'master', which sends the same clock signal to all the other ('slave') devices.

RME's exclusive **SyncCheck** technology enables an easy to use check and display of the current clock status. *SyncCheck* indicates whether there is a valid signal (Lock, No Lock) for each input (Word Clock, ADAT1, ADAT2, SPDIF), or if there is a valid *and* synchronous signal (Sync). The *AutoSync Ref* display shows the input and frequency of the current sync source (see chapter 35.1).

In practice, SyncCheck provides the user with an easy way of checking whether all digital devices connected to the system are properly configured. With SyncCheck, finally anyone can master this common source of error, previously one of the most complex issues in the digital studio world.

---

### 19.3 Limit Bandwidth

This option allows to reduce the amount of bandwidth used on the FireWire bus. A typical example is the use of the Fireface with a laptop. Only in rare cases both ADAT ports are needed, in many cases even both stay unused. The option *Analog+SPDIF* will reduce the amount of constantly (!) transferred data from around 5 MByte (10 in both directions) to only 2 MByte (4 in both directions). The FireWire connection will be more stable, reliable and robust, leaving additional bandwidth for other devices. At the same time the CPU and system load is reduced, as less channels have to be processed and to be transferred. In TotalMix, the deactivated software playback channels will be replaced with empty plates. More details are found in chapter 35.4.

#### Available Settings

*All channels* (default) activates all 28 input and output channels.

*Analog + SPDIF + ADAT1* disables channels 21–28 (ADAT2).

*Analog + SPDIF* activates all 10 analog channels plus SPDIF.

*Analog 1-8* activates only the first eight analog channels.



---

## 20. Mac OS X FAQ

### 20.1 Round about Driver Installation

The driver with the file suffix **zip** provided by RME is a compressed archive. Zip is directly supported by OS X, a double click on the file is all one needs to do.

The driver consists of a package file (pkg). A double click will start the OS X installer.

The actual audio driver appears as a kernel extension file. The installer copies it to **>System/Library/Extensions<**. Its name is **FirefaceAudioDriver.kext**. It is visible in the Finder, allowing you to verify date and driver version. Yet, in fact this again is a folder containing subdirectories and files.

Nonetheless, this 'driver file' can be removed by simply dragging it to the trash bin. This can be helpful in case a driver installation fails.

### 20.2 Repairing Disk Permissions

Repairing permission can solve problems with the installation process - plus many others. To do this, launch **Disk Utility** located in **Utilities**. Select your system drive in the drive/volume list to the left. The **First Aid** tab to the right now allows you to check and repair disk permissions.

### 20.3 MIDI doesn't work

In some cases MIDI does not work after the installation of the Fireface driver. To be precise, applications do not show an installed MIDI port. The reason for this is usually visible within the **Audio MIDI Setup**. It displays no RME MIDI device, or the device is greyed out and therefore inactive. Mostly, removing the greyed out device and searching for MIDI devices again will solve the problem. If this does not help, we recommend manual removal of the MIDI driver and reinstallation of the complete driver. Otherwise repairing permissions may help.

The Fireface MIDI driver is a plugin. During installation it will be copied to **>Library/Audio/MIDI Drivers<**. Its name is **Fireface MIDI.plugin**. The file can be displayed in the Finder and also be removed by simply dragging it to the trash bin.

### 20.4 Various Information

Via **>System Preferences/Audio-MIDI Setup<** the hardware can be configured for the system wide usage. Programs that don't support card or channel selection will use the device selected as **Standard-Input** and **Standard-Output**. (Soundstudio, Mplayer, Amplitude etc.).

In the lower part of the window, the audio hardware's capabilities are shown and can be changed in some cases. On the record side no changes are possible. Programs that don't support channel selection will always use channels 1/2, the first stereo pair. To access other inputs, use the following workaround with TotalMix: route the desired input signal to output channels 1/2. Hold the Ctrl key down and click on the labels AN1 and AN2 in the third row. Their labels turn red, the internal loop mode is active. Result: the desired input signal is now available at input channel 1/2, without further delay/latency.

Use **Speaker Setup** to freely configure the playback to all available channels. Even multichannel playback (Surround, DVD Player) can be set up this way.

---

## 20.5 Supported Sample Rates

RME's Mac OS X driver supports all sampling frequencies provided by the hardware. This includes **32 kHz** and **64 kHz**, and even **128 kHz**, **176.4 kHz** and **192 kHz**.

But not any software will support all the hardware's sample rates. The hardware's capabilities can easily be verified in the **Audio MIDI Setup**. Select **Audio devices** under **Properties of:** and choose the Fireface. A click on **Format** will list the supported sample frequencies.

## 20.6 Channel Count under Core Audio

At a sample rate of 88.2 or 96 kHz, the ADAT optical input and outputs operate in S/MUX mode, so the number of available channels per port is reduced from 8 to 4.

It is not possible to change the number of Core Audio devices without a reboot of the computer. Therefore whenever the Fireface 400 changes into Double Speed (88.2/96 kHz) or Quad Speed mode (176.4/192 kHz) all devices stay present, but become partly inactive.

Single Speed	Double Speed	Quad Speed
Fireface Analog 1 bis 8	Fireface Analog 1 bis 8	Fireface Analog 1 bis 8
Fireface SPDIF L / R	Fireface SPDIF L / R	Fireface SPDIF L / R
Fireface ADAT 1 bis 8	Fireface ADAT 1 bis 8	Fireface ADAT 1 bis 8
Fireface ADAT 9 bis 16	Fireface ADAT 9 bis 16	Fireface ADAT 9 bis 16

## 20.7 FireWire Compatibility

RME's Fireface 800 should be fully compatible to any FireWire port found on Apple Mac computers. Problems are known with FireWire controllers from LSI Agere Revision 6. Although we tested compatibility with lots of models, total compatibility can not be guaranteed. In case of trouble please contact RME.

---

## 21. Using more than one Fireface

OS X supports the usage of more than one audio device within an audio software. This is done via the Core Audio function **Aggregate Devices**, which combines several devices into one.

The current driver supports up to three Fireface 400 or 800. All units have to be in sync, i.e. have to receive valid sync information (either via word clock or by using AutoSync and feeding synchronized signals).

- If one of the Firefaces is set to clock mode Master, all others have to be set to clock mode Slave, and have to be synced from the master, for example by feeding word clock. The clock modes of all units have to be set up correctly in the Fireface Settings dialog.
- If all units are fed with a synchronous clock, i.e. all units show *Sync* in their Settings dialog, all channels can be used at once.

When using more than one Fireface 400/800 the FireWire bus might get overloaded. To prevent this connect all units to different busses.

Note: TotalMix is part of the hardware of each Fireface. Up to three mixers are available, but these are separated and can't interchange data. Therefore a global mixer for all units is not possible.

## 22. DIGICheck Mac

The DIGICheck software is a unique utility developed for testing, measuring and analysing digital audio streams. Although this Windows software is fairly self-explanatory, it still includes a comprehensive online help. DIGICheck 0.65 operates in parallel to any software, showing all input data. The following is a short summary of the currently available functions:

- **Level Meter.** High precision 24-bit resolution, 2/10/28 channels. Application examples: Peak level measurement, RMS level measurement, over-detection, phase correlation measurement, dynamic range and signal-to-noise ratios, RMS to peak difference (loudness), long term peak measurement, input check. Oversampling mode for levels higher than 0 dBFS. Supports visualization according to the K-System.
- **Hardware Level Meter for Input, Playback and Output.** Reference Level Meter freely configurable, causing near zero CPU load, because calculated from the Fireface hardware.
- **Spectral Analyser.** World wide unique 10-, 20- or 30-band display in analog bandpass filter technology. 192 kHz-capable!
- **Vector Audio Scope.** World wide unique Goniometer showing the typical afterglow of a oscilloscope-tube. Includes Correlation meter and level meter.
- **Totalyser.** Spectral Analyser, Level Meter and Vector Audio Scope in a single window.
- **Surround Audio Scope.** Professional Surround Level Meter with extended correlation analysis, ITU weighting and ITU summing meter.
- **ITU1770/EBU R128 Meter.** For standardized loudness measurements.
- **Bit Statistics & Noise.** Shows the true resolution of audio signals as well as errors and DC offset. Includes Signal to Noise measurement in dB and dBA, plus DC measurement.
- **Completely multi-client.** Open as many measurement windows as you like, on any channels and inputs or outputs!

To install DIGICheck, go to the **\DIGICheck** directory on the RME Driver CD and run *setup.exe*. Follow the instructions prompted on the screen.

DIGICheck is constantly updated. The latest version is always available on our website [www.rme-audio.com](http://www.rme-audio.com), section **Downloads / DIGICheck**.

---

## 23. Hotline – Troubleshooting

The newest information can always be found on our website [www.rme-audio.com](http://www.rme-audio.com), section Support, Macintosh OS. A report about incompatible FireWire 800 controllers is found in the Tech Info *FireWire 800 Hardware – Compatibility Problems*.

*The unit and drivers have been installed correctly, but playback does not work:*

- Is Fireface 800 listed in the System Profiler? (Vendor ID 2613, 800 MB/s).
- Has Fireface been selected as current playback device in the audio application?

*The 8 ADAT channels don't seem to work*

- The optical output ADAT2 has been switched to SPDIF. As can be seen in the block diagram, all channels and their assignments still exist, but the optical transmitter has been disconnected from ADAT2 and is now fed from the SPDIF output (channels 11/12). The ADAT2 playback devices are still usable by routing and mixing them in TotalMix to other outputs.

*Playback works, but record doesn't:*

- Check that there is a valid signal at the input. If so, the current sample frequency is displayed in the Settings dialog.
- Check whether the Fireface 800 has been selected as recording device in the audio application.
- Check whether the sample frequency set in the audio application ('Recording properties' or similar) matches the input signal.
- Check that cables/devices have not been connected in a closed loop. If so, set the system's clock mode to 'Master'.

*Crackle during record or playback:*

- Increase the number and size of buffers in the application.
- Try different cables (coaxial or optical) to rule out any defects here.
- Check that cables/devices have not been connected in a closed loop. If so, set the system's clock mode to 'Master'.
- Check the Settings dialog for displayed Errors.

*Possible causes for a Fireface not working*

- The FireWire cable is not, or not correctly inserted into the socket
- No power. After switching the Fireface on, at least the red Host error LED has to be lit.

*Driver installation and Settings dialog/TotalMix work, but a playback or record is not possible*

- While recognition and control of the device are low bandwidth applications, playback/record needs the full FireWire transmission performance. Therefore, defective FireWire cables with limited transmission bandwidth can cause such an error scheme.

---

## User's Guide



# Fireface 800

- ▶ **Stand-Alone Operation, Connections and TotalMix**

---

## 24. Stand-alone Operation

The Fireface 800 has an internal memory to permanently store all configuration data. These are:

### Settings dialog

Sample rate, clock mode Master/Slave, configuration of the channels and the digital I/Os.

### TotalMix

The complete mixer state.

The Fireface loads those settings directly after power-on. A simple, yet useful application is to store the correct clock mode, avoiding wrong clocking and noise disturbances in a complex setup, caused by wrong synchronization. Usually the unit will be configured by the Windows driver, so for the time between power-on of the computer up to the loading of the Windows driver its state might be wrong.

This total configuration feature in stand-alone operation - without any connected computer - turns the Fireface into lots of dedicated devices. Furthermore TotalMix (and with this all following examples) can be MIDI controlled even in stand-alone operation, see chapter 32.7, *Stand-Alone MIDI Control*.

### 24.1 10-Channel AD/DA-Converter

When loading TotalMix' factory default 1 into the unit, the Fireface becomes a high quality 10-channel AD/DA-converter, which also provides a monitoring of all 8 DA-channels via channels 9/10 (Preset 2: also monitoring all 10 inputs). A small modification allows for a monitoring of all I/Os via the SPDIF I/O.

### 24.2 4-Channel Mic Preamp

Use TotalMix to route the four microphone inputs directly to the analog outputs. This turns the Fireface 800 into a 4-channel microphone preamp. The AD- and DA-conversion will cause a small delay of the signals of around 0.4 ms (at 192 kHz, see chapter 35.2). But this is not really relevant, as it is the same delay that would be caused by changing the microphone's position by about 14 centimeter (5.6 inches).

### 24.3 Monitor Mixer

TotalMix allows ANY configuration of all I/Os of the Fireface. For example, set up the device as monitor mixer for 10 analog signals, 16 digital via ADAT and 2 via SPDIF. Additionally, TotalMix lets you set up ANY submixes, so all existing outputs can be used for different and independent monitorings of the input signals. The perfect headphone monitor mixer!

### 24.4 Digital Format Converter

As TotalMix allows for any routing of the input signals, the Fireface 800 can be used as ADAT to SPDIF converter, ADAT to two ADAT splitter, and SPDIF to ADAT converter.

### 24.5 Analog/digital Routing Matrix

The Matrix in TotalMix enables you to route and link all inputs and outputs completely freely. All the above functionalities are even available simultaneously, can be mixed and combined in many ways. Simply said: the Fireface 800 is a perfect analog/digital routing matrix!

---

## 25. Analog Inputs

### 25.1 Line Rear

The Fireface has eight balanced Line inputs as 1/4" TRS jacks on the back of the unit. The electronic input stage is built in a servo balanced design which handles unbalanced (mono jacks) and balanced (stereo jacks) correctly, automatically adjusting the level reference.



*When using unbalanced cables with TRS jacks: be sure to connect the 'ring' contact of the TRS jack to ground. Otherwise noise may occur, caused by the unconnected negative input of the balanced input.*

One of the main issues when working with an AD-converter is to maintain the full dynamic range within the best operating level. Therefore the Fireface 800 internally uses hi-quality electronic switches, which allow for a perfect adaptation of all rear inputs to the three most often used studio levels.

The 'standardized' studio levels do not result in a (often desired) full scale level, but take some additional digital headroom into consideration. The amount of headroom is different in different standards, and again differently implemented by different manufacturers. Because of this we decided to define the levels of the Fireface in the most compatible way.

Reference	0 dBFS @	Headroom
Lo Gain	+19 dBu	15 dB
+4 dBu	+13 dBu	9 dB
-10 dBV	+2 dBV	12 dB

With +4 dBu selected, the according headroom meets the latest EBU recommendations for Broadcast usage. At -10 dBV a headroom of 12 dB is common practice, each mixing desk operating at -10 dBV is able to send and receive much higher levels. Lo Gain is best suited for professional users who prefer to work balanced and at highest levels. Lo Gain provides 15 dB headroom at +4 dBu nominal level.

The above levels are also found in our ADI-8 series of AD/DA converters, the Multiface, and even in our Mic-Preamps QuadMic and OctaMic. Therefore all RME devices are fully compatible to each other.

### 25.2 Microphone / Line Front

The balanced microphone inputs of the Fireface 800 offer an adjustable gain of 10 to 60 dB. The soft switching, hi-current Phantom power (48 Volt) provides a professional handling of condenser mics. The mic preamp's discreet Class-A front end guarantees a superior sound quality.

With the balanced Line input, which can be used alternatively or at the same time as the microphone, the Fireface 800 becomes even more flexible. 10 kOhm input impedance, stereo TRS jack and adjustable input sensitivity in a range of 50 dB – this all guarantees that the front-side Line inputs can be used perfectly with keyboards, sampler, active guitars and much more.

The Line inputs handle levels from -28 dBu up to +22 dBu. Two LEDs display a present signal (from -45 dBFS on) and warn against overload (-2 dBFS).

Channels 7/8 can be switched between Line rear, microphone, and Line/microphone simultaneously in the Settings dialog. The front Line input can be used simultaneously with the microphone input. This way, up to three different sound sources (Line rear, Line front, microphone) may be recorded at the same time on one channel.

---

## 25.3 Instrument

The instrument input of the Fireface 800 has been optimized especially for guitar and bass. A soft clipping function limits the level from  $-10$  dBFS on, and offers tube-like distortion at full overload. The extra Drive stage adds even more distortion and also increased sustain. The Speaker Emulator gently shapes the sound for an optimal recording experience.

### LIM

The distortion caused by the clipping function of the instrument input is audible. Depending on use and application the new harmonics can be nice or disturbing:

- The guitar's volume pot can blend from clean up to full distortion
- A rhythm guitar's sound is enhanced by a popular tube-like sound
- All dynamic peaks of a slapped bass guitar are removed without audible artifacts
  
- An accurately played clean acoustic guitar will sound crunchy
- Steady tones sound distorted (guitar / keyboards / bass)

Therefore the Limiter can be switched off in the Settings dialog (*Instrument Options Lim.*). Technically this is done by applying a digital gain of 12 dB to the input signal. This way, the analog limiter does no longer reach its threshold of  $-10$  dBFS. But as this also changes the reference level of the rear input, the Limiter can only be disabled with input channel *Front* selected.

The digital gain for the instrument input may sound unusual at first. But the AD-converters of the Fireface 800 are much better than the dynamic ratio of any instrument recording, so when intentionally not recording at fullest level, nothing is lost. At higher gain (=distortion) of the input using a guitar, switching off the Limiter causes digital distortion, which adds nicely to the analog distortion of the input. Just give it a try...

The Line inputs of the microphone channels can also be used as instrument inputs. Active instruments can be connected directly and be level-adjusted perfectly with the Gain pots. Passive e-guitars require an additional impedance buffer. Most guitarists have one, but don't know that they do. Modern floor effects devices are active even in bypass mode, and then operate as impedance buffer.

### Drive

Drive is an additional clipper, for 25 dB more gain (=sustain) plus substantially higher distortion. It will simply blow you away. Also well suited for bass guitar.

### Speaker Emulation

The basic idea of the Fireface 800 instrument input is not to alter the sound in a specific way, but to pre-condition the sound so that it gets much easier recorded and processed within the DAW application. This is accomplished by an optimization of the input/record signal via:

- light pre-clipping (see above)
- removing low frequency noise
- removing high-frequency noise
- a small bass and presence boost

All frequency corrections are part of the *Speaker Emulation* option. The name is originated by the fact that guitar cabinets typically show a big level attenuation in the high frequency range, making distortion sound less brilliant and harsh. After activating this option, a guitar completely distorted by LIM and Drive will sound excellent even when played directly into a mixing desk.



---

## 26. Analog Outputs

### 26.1 Line

The eight short circuit protected, low impedance line outputs are available as 1/4" TRS jacks on the back of the unit. The electronic output stage is built in a servo balanced design which handles unbalanced (mono jacks) and balanced (stereo jacks) correctly.

To maintain an optimum level for devices connected to the analog outputs, the Fireface 800 internally uses hi-quality electronic switches, which allow for a perfect adaptation of all outputs to the three most often used studio levels.

As with the analog inputs, the analog output levels are defined to maintain a problem-free operation with most other devices. The headroom of the Fireface 800 lies between 9 and 15 dB, according to the chosen reference level:

Reference	0 dBFS @	Headroom
Hi Gain	+19 dBu	15 dB
+4 dBu	+13 dBu	9 dB
-10 dBV	+2 dBV	12 dB

With +4 dBu selected, the according headroom meets the latest EBU recommendations for Broadcast usage. At -10 dBV a headroom of 12 dB is common practice, each mixing desk operating at -10 dBV is able to send and receive much higher levels. Lo Gain is best suited for professional users who prefer to work balanced and at highest levels. Lo Gain provides 15 dB headroom at +4 dBu nominal level.

The above levels are also found in our ADI-8 series of AD/DA converters, the Multiface, and even in our Mic-Preamps QuadMic and OctaMic. Therefore all RME devices are fully compatible to each other.

### 26.2 Headphones

Channels 9/10 of the Fireface are available on the front via one 1/4" unbalanced TRS jack (stereo output). These channels use the same converters as the other Line outputs, therefore offer the same technical data (119 dBA SNR!).

Instead of using internal electronic switches, their output level is changed step-less with the VOL pot. These outputs are special low impedance types, ready to be used with headphones. But they can also be used as high-quality (yet unbalanced) Line outputs.

Like all other outputs, channels 9/10 can also be controlled by TotalMix regarding level and monitoring of any input or playback channels (submix, like factory presets 1 and 2).

In case the output should operate as line output, an adapter TRS plug to RCA phono plugs, or TRS plug to TS plugs is required.

The pin assignment follows international standards. The left channel is connected to the tip, the right channel to the ring of the TRS jack/plug.

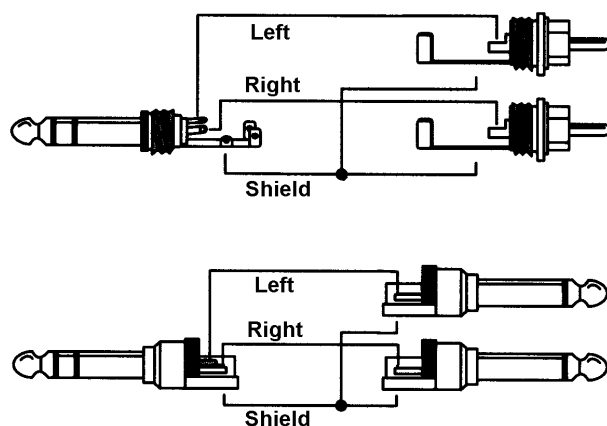

---

## 27. Digital Connections

### 27.1 ADAT

The ADAT optical inputs of the Fireface 800 are fully compatible with all ADAT optical outputs. RME's unsurpassed Bitclock PLL prevents clicks and drop outs even in extreme varipitch operation, and guarantees a fast and low jitter lock to the digital input signal. A usual TOSLINK cable is sufficient for connection. More information on Double Speed (S/MUX) can be found in chapter 37.5.

#### ADAT1 In

Interface for the first or only device sending an ADAT signal to the Fireface 800. Carries the channels 1 to 8. When receiving a Double Speed signal, this input carries the channels 1 to 4.

#### ADAT2 In

Interface for the second device sending an ADAT signal to the Fireface 800. Carries the channels 9 to 16. When receiving a Double Speed signal, this input carries the channels 5 to 8. Can also be used as SPDIF optical input.

#### ADAT1 Out

Interface for the first or only device receiving an ADAT signal from the Fireface 800. Transmits channels 1 to 8. When sending a Double Speed signal, this port carries channels 1 to 4.

#### ADAT2 Out

Interface for the second device receiving an ADAT signal from the Fireface 800. Transmits channels 9 to 16. When sending a Double Speed signal, this port carries channels 5 to 8. Can also be used as SPDIF optical output.

### 27.2 SPDIF

The SPDIF input is configured in the Settings dialog, available by a click on the fire symbol in the Task Bar's system tray. The Fireface 800 accepts all commonly used digital sources as well as SPDIF and AES/EBU. Channel status and copy protection are ignored.

To receive signals in AES/EBU format, an adapter cable is required. Pins 2 and 3 of a female XLR plug are connected individually to the two pins of a phono plug.

The cable shielding is only connected to pin 1 of the XLR - not to the phono plug.

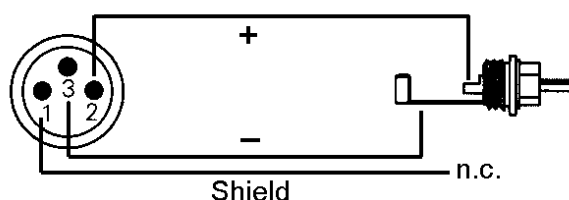

The ground-free design, with transformers for coaxial digital inputs and outputs, offers a trouble-free connection of all devices along with perfect hum rejection and full AES/EBU compatibility.

In SPDIF mode, identical signals are available at both the optical and the coaxial output. An obvious use for this would be to connect two devices, i.e. using the Fireface 800 as a splitter (distribution 1 on 2).

---

### Special Characteristics of the SPDIF Output

Apart from the audio data itself, digital signals in SPDIF or AES/EBU format have a header containing channel status information. False channel status is a common cause of malfunction. The Fireface 800 ignores the received header and creates a totally new one for the output signal.

 *Note that in record or monitor modes, set emphasis bits will disappear. Recordings originally done with emphasis should always be played back with the emphasis bit set!*

This can be done by selecting the *Emphasis* switch in the Settings dialog (*SPDIF Out*). This setting is updated immediately, even during playback.

Note: Recordings with (pre-) emphasis show a treble boost (50/15  $\mu$ s), which has to be compensated at playback. Therefore, when selecting *Emphasis* all analog outputs will be processed by a treble filter based on 50/15 $\mu$ s, which sounds like a high cut.

The Fireface's new output header is optimized for largest compatibility with other digital devices:

- 32 kHz, 44.1 kHz, 48 kHz, 88.2 kHz, 96 kHz, 176.4 kHz, 192 kHz depending on the current sample rate
- Audio use, Non-Audio
- No Copyright, Copy Permitted
- Format Consumer or Professional
- Category General, Generation not indicated
- 2-channel, No Emphasis or 50/15  $\mu$ s
- Aux bits Audio Use

Professional AES/EBU equipment can be connected to the Fireface 800 thanks to the transformer-balanced coaxial outputs, and the 'Professional' format option with doubled output voltage. Output cables should have the same pinout as those used for input (see above), but with a male XLR plug instead of a female one.

 *Note that most consumer HiFi equipment (with optical or phono SPDIF inputs) will only accept signals in 'Consumer' format!*

The audio bit in the header can be set to 'Non-Audio'. This is often necessary when Dolby AC-3 encoded data is sent to external decoders (surround-sound receivers, television sets etc. with AC-3 digital inputs), as these decoders would otherwise not recognize the data as AC-3.

### 27.3 MIDI

Fireface 800 offers one MIDI I/O via two 5-pin DIN jacks. The MIDI ports are added to the system by the driver. Using MIDI capable software, these ports can be accessed under the name *Fireface Midi*. Using more than one Fireface, the operating system adds a consecutive number to the port name, like *Fireface MIDI (2)* etc.

The MIDI ports support multi-client operation. A MIDI input signal can be received from several programs at the same time. Even the MIDI output can be used by multiple programs simultaneously. However, due to the limited bandwidth of MIDI, this kind of application will often show various problems.

Note: The MIDI input LED displays any kind of MIDI activity, including MIDI Clock, MTC and Active Sensing. The latter is sent by most keyboards every 0.3 seconds.

---

## 28. Word Clock

### 28.1 Word Clock Input and Output

*SteadyClock* guarantees an excellent performance in all clock modes. Based on the highly efficient jitter suppression, the Fireface refreshes and cleans up any clock signal, and provides it as reference clock at the BNC output (see section 35.9).

#### Input

The Fireface's transformer isolated word clock input is active when *Pref. Sync Ref* in the Settings dialog has been switched to *Word Clock*, the clock mode *AutoSync* has been activated, and a valid word clock signal is present. The signal at the BNC input can be Single, Double or Quad Speed, the Fireface 800 automatically adapts to it. As soon as a valid signal is detected, the WC LED is lit, and the Settings dialog shows either Lock or Sync (see chapter 35.1).

Thanks to RME's *Signal Adaptation Circuit*, the word clock input still works correctly even with heavily mis-shaped, dc-prone, too small or overshoot-prone signals. Thanks to automatic signal centering, 300 mV (0.3V) input level are sufficient in principle. An additional hysteresis reduces sensitivity to 1.0 V, so that over- and undershoots and high frequency disturbances don't cause a wrong trigger.

The Fireface's word clock input is shipped as high impedance type (not terminated). A push switch allows to activate internal termination (75 Ohms). The switch is found on the back beside the word clock input socket. Use a small pencil or similar and carefully push the blue switch so that it snaps into its lock position. The yellow LED will be lit when termination is active. Another push will release it again and de-activate the termination.



#### Output

The word clock output of the Fireface is constantly active, providing the current sample frequency as word clock signal. As a result, in Master mode the provided word clock is defined by the currently used software. In Slave mode the provided frequency is identical to the one present at the currently chosen clock input. When the current clock signal fails, the Fireface 800 switches to Master mode and adjusts itself to the next, best matching frequency (44.1 kHz, 48 kHz etc.).

Selecting *Single Speed* in the Settings dialog causes the output signal to always stay within the range of 32 kHz to 48 kHz. So at 96 kHz and 192 kHz sample rate, the output word clock is 48 kHz.

The received word clock signal can be distributed to other devices by using the word clock output. With this the usual T-adaptor can be avoided, and the Fireface 800 operates as *Signal Refresher*. This kind of operation is highly recommended, because

- input and output are phase-locked and in phase (0°) to each other
- *SteadyClock* removes nearly all jitter from the input signal
- the exceptional input (1 Vpp sensitivity instead of the usual 2.5 Vpp, dc cut, *Signal Adaptation Circuit*) plus *SteadyClock* guarantee a secure function even with highly critical word clock signals

Thanks to a low impedance, but short circuit proof output, the Fireface delivers 4 Vpp to 75 Ohms. For wrong termination with 2 x 75 Ohms (37.5 Ohms), there are still 3.3 Vpp at the output.

---

## 28.2 Technical Description and Usage

In the analog domain one can connect any device to another device, a synchronization is not necessary. Digital audio is different. It uses a clock, the sample frequency. The signal can only be processed and transmitted when all participating devices share the same clock. If not, the signal will suffer from wrong samples, distortion, crackle sounds and drop outs.

AES/EBU, SPDIF and ADAT are self-clocking, an additional word clock connection in principle isn't necessary. But when using more than one device simultaneously problems are likely to happen. For example any self-clocking will not work in a loop cabling, when there is no 'master' (main clock) inside the loop. Additionally the clock of all participating devices has to be synchronous. This is often impossible with devices limited to playback, for example CD players, as these have no SPDIF input, thus can't use the self clocking technique as clock reference.

In a digital studio synchronisation is maintained by connecting all devices to a central sync source. For example the mixing desk works as master and sends a reference signal, the word clock, to all other devices. Of course this will only work as long as all other devices are equipped with a word clock or sync input, thus being able to work as slave (some professional CD players indeed have a word clock input). Then all devices get the same clock and will work in every possible combination with each other.



*Remember that a digital system can only have one master! If the Fireface's clock mode is set to 'Master', all other devices must be set to 'Slave'.*

But word clock is not only the 'great problem solver', it also has some disadvantages. The word clock is based on a fraction of the really needed clock. For example SPDIF: 44.1 kHz word clock (a simple square wave signal) has to be multiplied by 256 inside the device using a special PLL (to about 11.2 MHz). This signal then replaces the one from the quartz crystal. Big disadvantage: because of the high multiplication factor the reconstructed clock will have great deviations called jitter. The jitter of a word clock is typically 15 times higher as when using a quartz based clock.

The end of these problems should have been the so called Superclock, which uses 256 times the word clock frequency. This equals the internal quartz frequency, so no PLL for multiplying is needed and the clock can be used directly. But reality was different, the Superclock proved to be much more critical than word clock. A square wave signal of 11 MHz distributed to several devices - this simply means to fight with high frequency technology. Reflections, cable quality, capacitive loads - at 44.1 kHz these factors may be ignored, at 11 MHz they are the end of the clock network. Additionally it was found that a PLL not only generates jitter, but also rejects disturbances. The slow PLL works like a filter for induced and modulated frequencies above several kHz. As the Superclock is used without any filtering such a kind of jitter and noise suppression is missing.

The actual end of these problems is offered by the **SteadyClock** technology of the Fireface 800. Combining the advantages of modern and fastest digital technology with analog filter techniques, re-gaining a low jitter clock signal of 22 MHz from a slow word clock of 44.1 kHz is no problem anymore. Additionally, jitter on the input signal is highly rejected, so that even in real world usage the re-gained clock signal is of highest quality.

---

## 28.3 Cabling and Termination

Word clock signals are usually distributed in the form of a network, split with BNC T-adapters and terminated with resistors. We recommend using off-the-shelf BNC cables to connect all devices, as this type of cable is used for most computer networks. You will find all the necessary components (T-adapters, terminators, cables) in most electronics and/or computer stores. The latter usually carries 50 Ohms components. The 75 Ohms components used for word clock are part of video technology (RG59).

Ideally, the word clock signal is a 5 Volt square wave with the frequency of the sample rate, of which the harmonics go up to far above 500 kHz. To avoid voltage loss and reflections, both the cable itself and the terminating resistor at the end of the chain should have an impedance of 75 Ohm. If the voltage is too low, synchronization will fail. High frequency reflection effects can cause both jitter and sync failure.

Unfortunately there are still many devices on the market, even newer digital mixing consoles, which are supplied with a word clock output that can only be called unsatisfactory. If the output breaks down to 3 Volts when terminating with 75 Ohms, you have to take into account that a device, of which the input only works from 2.8 Volts and above, does not function correctly already after 3 meter cable length. So it is not astonishing that because of the higher voltage, word clock networks are in some cases more stable and reliable if cables are not terminated at all.

Ideally all outputs of word clock delivering devices are designed as low impedance types, but all word clock inputs as high impedance types, in order to not weaken the signal on the chain. But there are also negative examples, when the 75 Ohms are built into the device and cannot be switched off. In this case the network load is often  $2 \times 75$  Ohms, and the user is forced to buy a special word clock distributor. Note that such a device is generally recommended for bigger studios.

The Fireface's word clock input can be high-impedance or terminated internally, ensuring maximum flexibility. If termination is necessary (e.g. because the Fireface is the last device in the chain), push the switch at the back beside the BNC socket (see chapter 28.1).

In case the Fireface 800 resides within a chain of devices receiving word clock, plug a T-adapter into its BNC input jack, and the cable supplying the word clock signal to one end of the adapter. Connect the free end to the next device in the chain via a further BNC cable. The last device in the chain should be terminated using another T-adapter and a 75 Ohm resistor (available as short BNC plug). Of course devices with internal termination do not need T-adapter and terminator plug.



*Due to the outstanding SteadyClock technology of the Fireface 800, we recommend not to pass the input signal via T-adapter, but to use the Fireface's word clock output instead. Thanks to SteadyClock, the input signal will both be freed from jitter and - in case of loss or drop out – be reset to a valid frequency.*

## 28.4 Operation

The green Lock LED on the front (DIGITAL STATE) will light up as soon as a word clock signal is detected. To change to word clock as clock source, activate clock mode *AutoSync* and switch *Pref. Sync Ref* to *Word Clock* within the Settings dialog. The status display *AutoSync Ref* changes to *Word* as soon as a valid signal is present at the BNC jack. This message has the same meaning as the green *Lock* LED, but appears on the monitor, i.e. the user can check immediately whether a valid word clock signal is present and is currently being used.

*AutoSync Ref* also displays the frequency (*Freq.*) of the reference signal, here the frequency of the current word clock signal, measured by the hardware.

---

## 29. TotalMix: Routing and Monitoring

### 29.1 Overview

The Fireface 800 includes a powerful digital real-time mixer, the *Fireface mixer*, based on RME's unique, sample-rate independent **TotalMix** technology. It allows for practically unlimited mixing and routing operations, with all inputs and playback channels simultaneously, to any hardware outputs.

Here are some typical applications for TotalMix:

- Setting up delay-free submixes (headphone mixes). The Fireface allows for up to 14 (!) fully independent stereo submixes. On an analog mixing desk, this would equal 28 (!) Aux sends.
- Unlimited routing of inputs and outputs (free utilisation, patchbay functionality).
- Distributing signals to several outputs at a time. TotalMix offers state-of-the-art splitter and distributor functions.
- Simultaneous playback of different programs via a single stereo output. The ASIO multi-client driver supports the usage of several programs at the same time. When done on different playback channels TotalMix provides the means to mix and monitor these on a single stereo output.
- Mixing of the input signal to the playback signal (complete ASIO Direct Monitoring). RME not only is *the* pioneer of ADM, but also offers the most complete implementation of the ADM functions.
- Integration of external devices. Use TotalMix to insert external effects devices, be it in the playback or in the record path. Depending on the current application, the functionality equals insert or effects send and effects return, for example as used during real-time monitoring when adding some reverb to the vocals.

Every single input channel, playback channel and hardware output features a Peak and RMS level meter, calculated in hardware. These level displays are very useful to determine the presence and routing destinations of the audio signals.

For a better understanding of the TotalMix mixer you should know the following:

- As shown in the block diagram (next page), the record signal usually stays un-altered. TotalMix does not reside within the record path, and does not change the record level or the audio data to be recorded (exception: loopback mode).
- The hardware input signal can be passed on as often as desired, even with different levels. This is a big difference to conventional mixing desks, where the channel fader always controls the level for all routing destinations simultaneously.
- The level meter of inputs and playback channels are connected pre-fader, to be able to visually monitor where a signal is currently present. The level meters of the hardware's outputs are connected post-fader, thus displaying the actual output level.

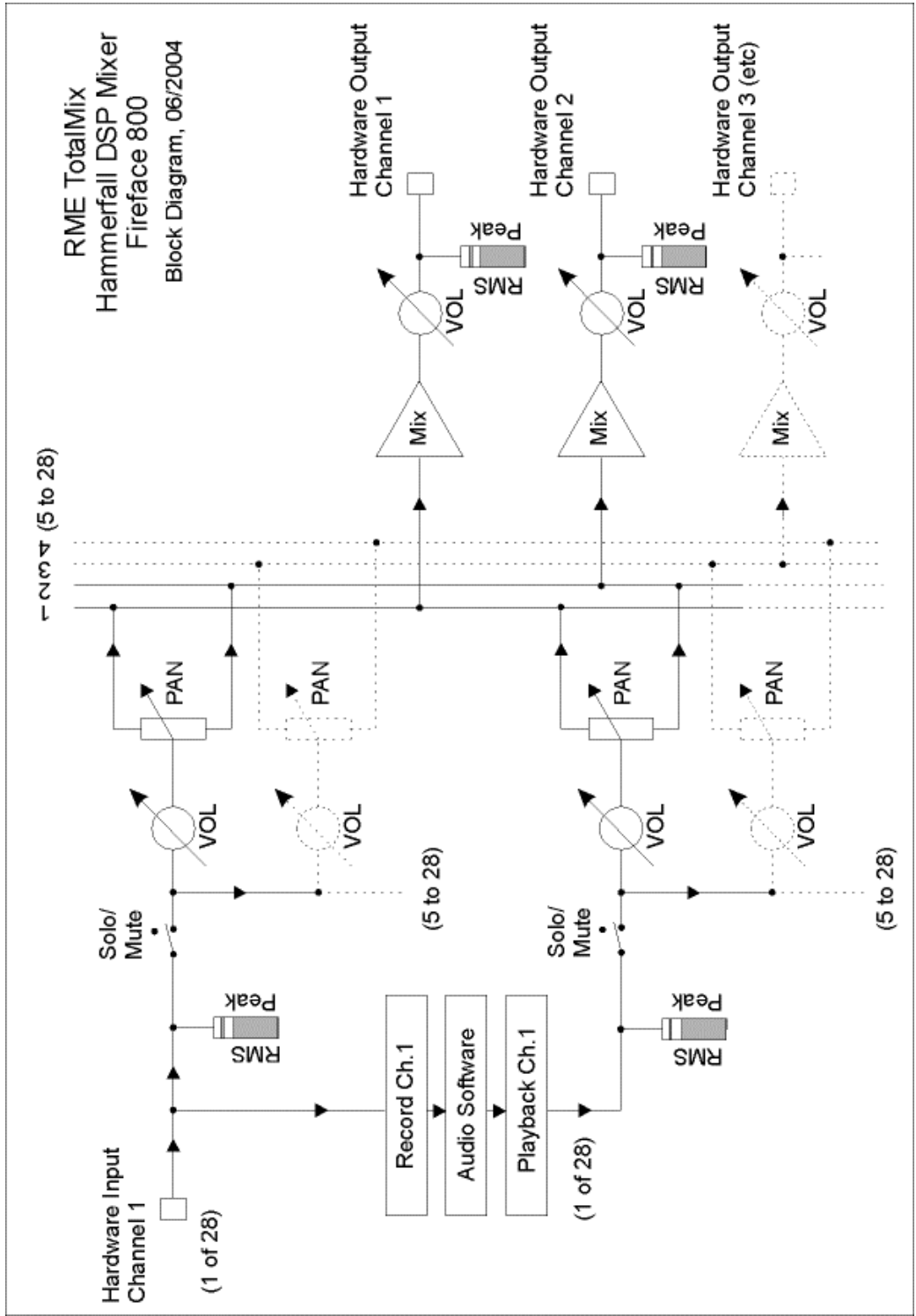



---

## 29.2 The User Interface

The visual design of the TotalMix mixer is a result of its capability to route hardware inputs and software playback channels to any hardware output. The Fireface 800 provides 28 input channels, 28 software playback channels, and 28 hardware output channels:

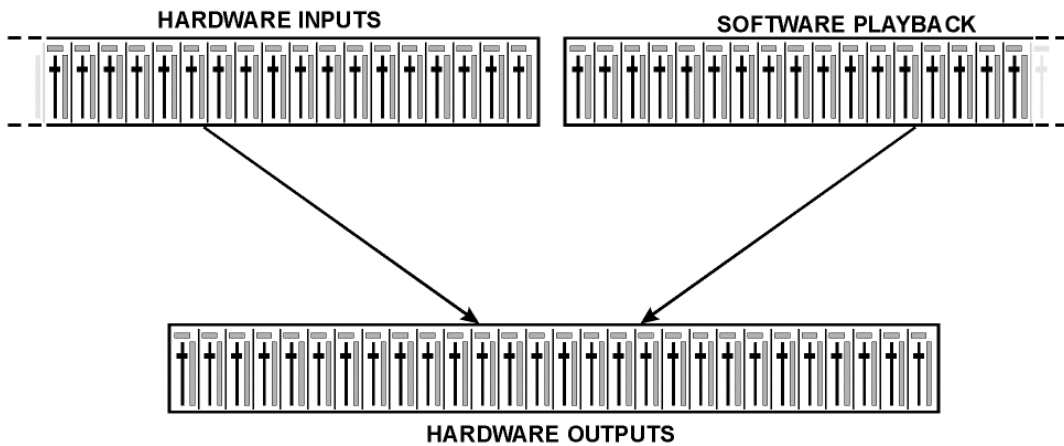

56 channels don't fit on the screen side by side, neither does such an arrangement provide a useful overview. Therefore, the channels have been arranged as known from an *Inline* desk, so that the row *Software Playback* equals the *Tape Return* of a real mixing desk:

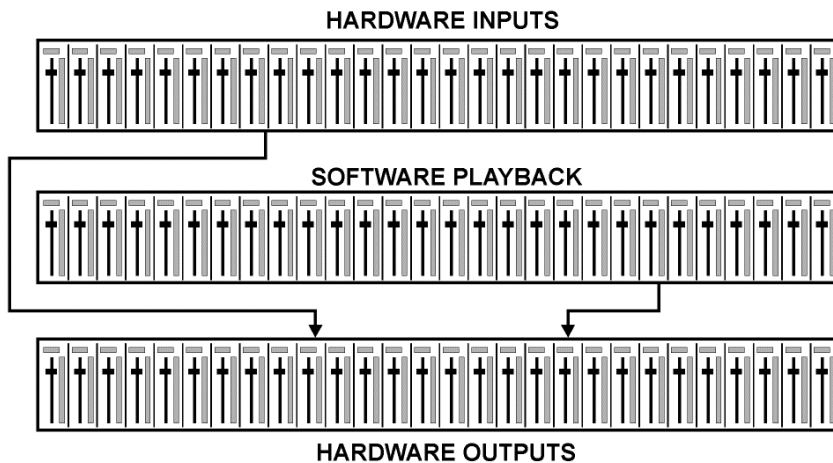

- Top row: Hardware inputs. The level shown is that of the input signal, i. e. fader independent. Via fader and routing field, any input channel can be routed and mixed to any hardware output (bottom row).
- Middle row: Playback channels (playback tracks of the audio software). Via fader and routing field, any playback channel can be routed and mixed to any hardware output (third row).
- Bottom row (third row): Hardware outputs. Here, the total level of the output can be adjusted. This may be the level of connected loudspeakers, or the necessity to reduce the level of an overloaded submix.

**Usage in mode Submix View (Default):** simply click on the hardware output channel where you want to have an audio signal. This channel turns brighter, means it is selected as current submix. Now move the faders up from all sources - input and playback channels - that you want to hear at the submix output.

The following chapters explain step by step all functions of the user interface.

---

## 29.3 Elements of a Channel

A single channel consists of various elements:

Input channels and playback channels each have a mute and solo button.

Below there is the panpot, realized as indicator bar (L/R) in order to save space.

In the field below, the present level is displayed in RMS or Peak, being updated about every half a second. Overs (overload) are indicated here by an additional red dot.

Next is the fader with a level meter. The meter shows both peak values (zero attack, 1 sample is enough for a full scale display) by means of a yellow line, and mathematically correct RMS values by means of a green bar. The RMS display has a relatively slow time constant, so that it shows the average loudness quite well.

Below the fader, the current gain and panorama values are shown.

The grey area shows the channel name. Selecting one or more channels is done by clicking on the white label which turns orange then. A click in the third row with pressed Ctrl-key activates internal loopback mode, the label turns red. A right mouse click opens a dialog to type in a new name.

The black area (routing field) shows the current routing target. A mouse click opens the routing window to select a routing target. The list shows all currently activated routings by checkmarks in front of the routing targets.



## 29.4 Tour de TotalMix

This chapter is a practical guide and introduction on how to use TotalMix and on how TotalMix works.

Starting up TotalMix the last settings are recalled automatically. When executing the application for the first time, a default file is loaded, sending all playback tracks 1:1 to the corresponding hardware outputs with 0 dB gain, and activating phones monitoring.

Hold down Ctrl and click on preset button 1 to make sure that factory preset 1 is loaded. The faders in the top row are set to maximum attenuation (called m.a. in the following), so there is no monitoring of the input channels. The **Submix View** is active, therefore for improved overview all outputs except Phones are greyed out. Additionally all faders are set to the routing target Phones. All faders of the middle row are set to 0 dB, so no matter on which channels a playback happens, the audio will be audible via the Phones output. Just try it!

We will now create a submix on analog outputs 1/2. Please start a multitrack playback. In the third row, click on the channels of hardware output AN1 or AN2. The Submix View changes from Phones to AN1/AN2. Both the fader settings and the output levels of all other channels are still visible, but greyed out for improved orientation.

As soon as AN1/AN2 became active, all faders of the second row jumped to their bottom position – except those of playback channel 1/2. This is correct, because as mentioned above the factory preset includes a 1:1 routing. Click on AN 3/4 and the faders above are the only active ones, same for AN5/6 and so on.

Back to AN1/2. Now you can change all the faders of all inputs and playback channels just as you like, thus making any input and playback signals audible via the outputs AN1/2. The panorama can be changed too. Click into the area above the fader and drag the green bar in order to set the panorama between left and right. The level meters of the third row display the level changes in real-time.

You see, it is very easy to set up a specific submix for whatever output: select output channel, set up fader and pans of inputs and playbacks – ready!

For advanced users sometimes it makes sense to work without Submix View. Example: you want to see and set up some channels of different submixes simultaneously, without the need to change between them all the time. Switch off the Submix View by a click on the green button. Now the black routing fields below the faders no longer show the same entry (AN1/2), but completely different ones. The fader and pan position is the one of the individually shown routing destination.

In playback channel 1 (middle row), labelled Out 1, click onto the routing field below the label. A list pops up, showing a checkmark in front of 'AN 1+2' and 'Phones'. So currently playback channel 1 is sent to these two routing destinations. Click onto 'AN 7+8'. The list disappears, the routing field no longer shows 'AN1+2', but 'AN 7+8'. Now move the fader with the mouse. As soon as the fader value is unequal m.a., the present state is being stored and routing is activated. Move the fader button to around 0 dB. The present gain value is displayed below the fader in green letters.

In the lower row, on channel 7, you can see the level of what you are hearing from output 7. The level meter of the hardware output shows the outgoing level. Click into the area above the fader and drag the mouse in order to set the panorama, in this case the routing between channels 7 and 8. The present pan value is also being displayed below the fader.

Please carry out the same steps for Out 2 now, in order to route it to output 8 as well.

In short: While editing the Submix AN7/AN8 you have direct access to other submixes on other channels, because their routing fields are set to different destinations. And you get a direct view of how their faders and panoramas are set up.

 *This kind of visual presentation is a mighty one, but for many users it is hard to understand, and it requires a deep understanding of complex routing visualizations. Therefore we usually recommend to work in **Submix View**.*

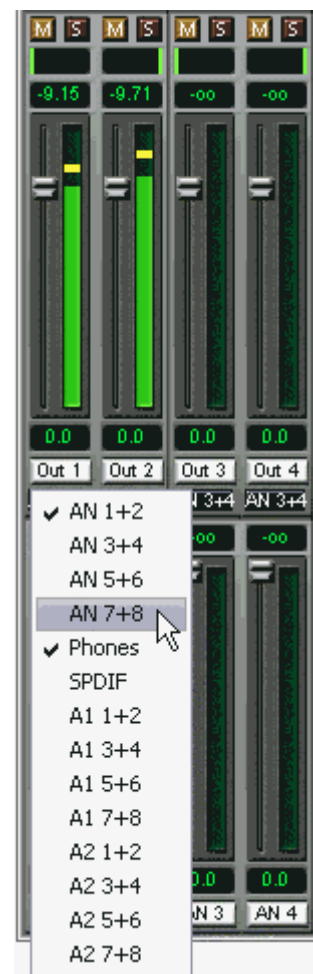

Often signals are stereo, i. e. a pair of two channels. It is therefore helpful to be able to make the routing settings for two channels at once. Hold down the Ctrl-key and click into the routing field of Out 3. The routing list pops up with a checkmark at 'AN 3+4'. Select 'AN 7+8'. Now, Out 4 has already been set to 'AN 7+8' as well.

When you want to set the fader to exactly 0 dB, this can be difficult, depending on the mouse configuration. Move the fader close to the 0 position and now press the Shift-key. This activates the fine mode, which stretches the mouse movements by a factor of 8. In this mode, a gain setting accurate to 0.1 dB is no problem at all.

---

Please set Out 4 to a gain of around -20 dB and the pan close to center. Now click onto the routing field. You'll now see two checkmarks, one at 'AN 3+4', the other one at 'AN 7+8'. Click onto 'SPDIF'. The window disappears, fader and pan jump to their initial values, the signal can now be routed to the SPDIF output. You can continue like this until all entries have got a checkmark, i. e. you can send the signal to all outputs simultaneously.

You will certainly have noticed that the signal at the outputs 7/8 did not change while you were routing channel 4 to other outputs and setting different gain values for those. With all analog and most digital mixing desks, the fader setting would affect the level for every routed bus - not so for TotalMix. TotalMix allows for setting all fader values individually. Therefore the faders and the panpots jump to the appropriate setting as soon as another routing is chosen.

Sometimes you will want the routings not to be independent. Let's say you have sent a signal to several submixes, and now want to change the signal's volume a bit on *all* these submixes. Dragging the faders by use of the right mouse button activates **Post Send** mode and causes all routings of the current input or playback channel to be changed in a relative way. Please note that the fader settings of all routings are memorized. So when pulling the fader to the bottom (maximum attenuation), the individual settings are back when you right click the mouse and pull the fader up. The individual settings get lost in m.a. position as soon as the fader is clicked with the left mouse button. As long as no single level is at m.a. position, the left mouse button can be used to change the current routing's gain.

The checkmarks are un-checked by moving the fader to m.a. This setting deactivates the routing...why route if there is no level? Click onto 'AN 7+8' in the routing window, pull the fader down, open the routing window again - the checkmark is gone.

The number of ADAT channels is reduced automatically when entering Double Speed mode (96 kHz). The display is adjusted accordingly, and all fader settings remain stored. Changing into Quad Speed mode (192 kHz) all ADAT channels vanish. TotalMix then displays a total of only 12 channels.

## 29.5 Submix View

Such a wide range of possibilities make it difficult to maintain the overview. Because as shown practically all hardware outputs can be used for different submixes, (up to 14 completely independent stereo submixes, 7 4-channel submixes etc.). And when opening the routing windows you might see an army of checkmarks, but you don't get an overview, i.e. how the signals come together and where. This problem is solved by **Submix View** mode. In this mode, all routing fields jump to the routing pair just being selected. You can then see immediately, which channels, which fader and pan settings make a submix (for example 'AN 5+6'). At the same time the Submix View simplifies setting up the mixer, as all channels can be set simultaneously to the same routing destination with just one click.

Changing to a different destination (output channel) is done in any routing field, or by a click on the desired output pair in the bottom row.

## 29.6 Mute and Solo

Mute operates pre-fader, thus mutes all currently active routings of the channel. As soon as any Mute button is pressed, the *Mute Master* button lights up in the Quick Access area. With this all selected mutes can be switched off and on again. You can comfortably set up a mute-group or activate and deactivate several Mutes simultaneously.

The same holds true for the Solo and the *Solo Master* buttons. As with conventional mixing desks, Solo operates only for the output defined as **Monitor Main**, as a solo-in-place, post fader. As soon as one Solo button is pressed, the *Solo Master* button lights up in the Quick Access area. With this all selected Solos can be switched off and on again. You can comfortably set up a solo-group or activate and deactivate several Solos simultaneously.

---

## 29.7 The Quick Access Panel

This section includes additional options, further improving the handling of TotalMix. The Master buttons for Mute and Solo have already been described, they allow for group-based working with these functions.

In the **View** section the single mixer rows can be made visible or invisible. If the inputs are not needed for a pristine playback mix, the whole upper row falls out of the picture after a click on the Input button. If the hardware outputs don't interest you either, the window can thus be reduced to the playback channels to save space. All combinations are possible and allowed.

As described earlier, **Submix** sets all routing windows to the same selection. Deactivating Submix automatically recalls the previous view. The mixer can be made smaller horizontally and vertically. This way TotalMix can be made substantially smaller and space-saving on the desktop/screen, if you have to monitor or set only a few channels or level meters.

The **Presets** are one of the mightiest and most useful features of TotalMix. Behind the eight buttons, eight files are hidden (see next chapter). These contain the complete mixer state. All faders and other settings follow the changing of preset(s) in real-time, just by a single mouse click. The **Save** button allows for storing the present settings in any preset. You can change back and forth between a signal distribution, complete input monitoring, a stereo and mono mix, and various submixes without any problem.

If any parameter is being altered after loading a preset (e. g. moving a fader), the preset display flashes in order to announce that something has been changed, still showing which state the present mix is based on.

If no preset button is lit, another preset had been loaded via the **File** menu and **Open file**. Mixer settings can of course be saved the usual way, and have long file names.

Instead of single presets a complete bank of (8) presets can be loaded at once. Advantage: The names defined for the preset buttons will be stored and loaded automatically.

Up to three Firefaces can be used simultaneously. The **Unit** buttons switch between the devices. Holding down Ctrl while clicking on button Unit 2 or Unit 3 will open another TotalMix window.



## 29.8 Presets

TotalMix includes eight factory presets, stored within the program. The user presets can be changed at any time, because TotalMix stores and reads the changed presets from the files **preset11.fmx** to **preset81.fmx**, located in Windows' hidden directory *Documents and Settings, <Username>, Local Settings, Application Data, RME TotalMix*. On the Mac the location is in the folder *User, <Username>, Library / Preferences / Fireface*. The first number indicates the current preset, the second number the current unit.

This method offers two major advantages:

- Presets modified by the user will not be overwritten when reinstalling or updating the driver
- The factory presets remain unchanged, and can be reloaded any time.

---

**Mouse:** The original factory presets can be reloaded by holding down the Ctrl-key and clicking on any preset button. Alternatively the files described above can be renamed, moved to a different directory, or being deleted.

**Keyboard:** Using Ctrl and any number between 1 and 8 (not on the numeric keypad!) will load the corresponding factory default preset. The key Alt will load the user presets instead.

When loading a preset file, for example 'Main Monitor AN 1\_2 plus headphone mix 3\_4.fmx', the file name will be displayed in the title bar of the TotalMix window. Also when loading a preset by the preset buttons the name of the preset is displayed in the title bar. This way it is always clear what the current TotalMix state is based on.

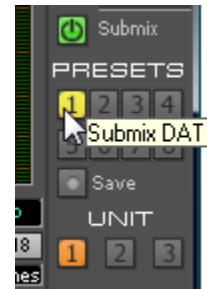

The eight factory presets offer a pretty good base to modify them to your personal needs. In all factory presets Submix View is active by default.

### Preset 1

Description: All channels routed 1:1, monitoring of all playback channels via Phones.

Details: All inputs maximum attenuation. All playback channels 0 dB, routed to the same output. All outputs 0 dB, Phones -6 dB. Submix of all inputs and playbacks to channel 9/10 (Phones). Level display RMS +3 dB. View Submix active.

Note: This preset is *Default*, offering the standard functionality of a I/O-system.

### Preset 2

Description: All channels routed 1:1, input and playback monitoring via Phones. As Preset 1, plus submix of all inputs (0 dB) to channels 9/10 (Phones).

### Preset 3

Description: All channels routed 1:1, input and playback monitoring via Phones and outputs. As Preset 2, but all inputs set to 0 dB (1:1 monitoring).

### Preset 4

Description: All channels routed 1:1, input and playback monitoring via Phones and outputs. As Preset 3, but all inputs muted.

### Preset 5

Description: Playback monitoring to Phones. As Preset 1, but all outputs except channels 9/10 (Phones) set to maximum attenuation.

### Preset 6

Description: All channels routed 1:1, monitoring of all playback channels via Phones and SPDIF. As Preset 1, plus submix of all playbacks to SPDIF.

### Preset 7

Description: Monitoring of all playback channels via Phones and of all input and playback channels via SPDIF. As Preset 2, plus submix of all inputs to SPDIF.

### Preset 8

Description: Panic. As Preset 4, but playback channels muted too (no output signal).

### Preset Banks

Instead of a single preset, all eight presets can be stored and loaded at once. This is done via Menu **File, Save All Presets as** and **Open All Presets** (file suffix .fpr). After the loading the presets can be activated by the preset buttons. In case the presets have been renamed (see chapter 29.11), these names will be stored and loaded too.

## 29.9 The Monitor Panel

The Monitor panel provides several options usually found on analog mixing desks. It offers quick access to monitoring functions which are needed all the time in typical studio work.

### Monitor Main

Use the drop down menu to select the hardware outputs where your main monitors are connected to.

### Dim

A click on this button will lower the volume of the *Monitor Main* output by an amount set up in the Preferences dialog (see below). This is the same as moving the third row faders down a bit, but much more convenient, as the old setting is back by a simple mouse click.

### Mono

Sets the stereo output defined above to monaural playback. Useful to check for mono compatibility and phase problems.

### Talkback

A click on this button will dim all signals on the *Monitor Phones* outputs by an amount set up in the Preferences dialog. At the same time the control room's microphone signal (source defined in Preferences) is sent to the three destinations *Monitor Phones* described below. The microphone level is adjusted with the channel's input fader.



### Monitor Phones 1/2/3

Use the drop down menu to select the hardware outputs where the submixes are sent to. These submixes are usually phones mixdowns for the musicians. A click on the button allows to hear the specific submix via the *Monitor Main* output. So when setting up or modifying the submix for the musician this process can be monitored easily and any time through the studio's monitors.

## 29.10 Preferences

The dialog box Preferences is available via the menu *Options* or directly via F3.

### Talkback

Input: Select the input channel of the Talkback signal (microphone in control room).

Dim: Amount of attenuation of the signals routed to the *Monitor Phones* in dB.

### Listenback

Input: Select the input channel of the Listenback signal (microphone in recording room).

Dim: Amount of attenuation of the signals routed to the *Monitor Main* in dB.

### Main Monitor

Dim: Amount of attenuation of the Monitor Main output in dB. Activated by the *Dim* button in the Monitor panel.

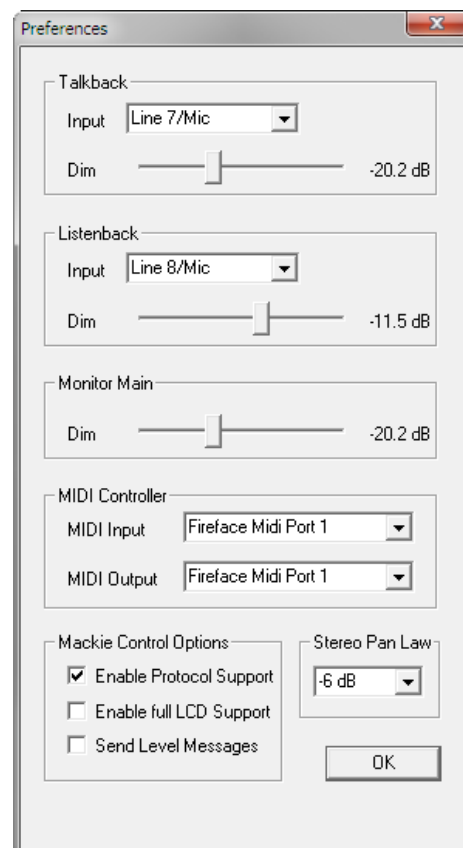

## MIDI Controller

MIDI Input: Input where TotalMix receives MIDI Remote data.

MIDI Output: Output where TotalMix sends MIDI Remote data.

## Mackie Control Options

Enable Protocol Support: When disabled TM FX will only react on the Control Change commands of chapter 28.5.

Enable full LCD support: Activates full Mackie Control LCD support with eight channel names and eight volume/pan values.

Send Level Messages: Activates the transmission of the level meter data.

## Stereo Pan Law

The Pan Law can be set to -6 dB, -4.5 dB, -3 dB and 0 dB. The value chosen defines the level attenuation in pan center position. This setting is useful because the ASIO host often supports different pan laws too. Selecting the same value here and in the ASIO host, ASIO Direct Monitoring works perfectly, as both ASIO host and TotalMix use the same pan law. Of course, when not using ADM it can be changed to a setting different from the factory preset of -6 dB as well. You will most probably find that -3 dB gives a much more stable loudness when moving an object between left and right.

## 29.11 Editing the Names

The channel names shown in the grey label area can be edited. A right mouse click on the grey name field brings up the dialog box **Enter Name**. Any name can be entered in this dialog. Enter/Return closes the dialog box, the grey label now shows the first letters of the new name. ESC cancels the process and closes the dialog box.



Moving the mouse above the label brings up a tool tip with the complete name.

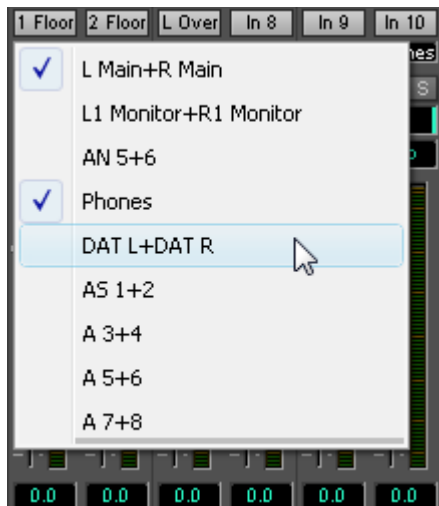

The hardware outputs (third row) can be edited in the same way. In this case, the names in the routing drop down menus will change automatically. Additionally the names in the drop down menu of the Monitor section will change as well.

The preset buttons can get meaningful names in the same way. Move the mouse over a preset button, a right mouse click will bring up the dialog box.

Note that the name shows up as tool tip only, as soon as the mouse stays over the preset button.



The preset button names are not stored in the preset files, but globally in the registry, so won't change when loading any file or saving any state as preset. But loading a preset bank (see chapter 29.8) the names will be updated.



---

## 29.12 Hotkeys

In many situations TotalMix can be controlled quickly and comfortably by the keyboard, making the mixer setup considerably easier and faster. The **Shift**-key for the fine mode for faders and panpots has already been mentioned. The **Ctrl**-key can do far more than changing the routing pairwise:

- Clicking anywhere into the fader area with the Ctrl-key pressed, sets the fader to 0 dB.
- Clicking anywhere into the pan area with the Ctrl-key pressed, sets the panorama to <C> meaning Center.
- Clicking a preset button while holding down Ctrl, the original factory preset will be loaded.
- Using Ctrl and any number between 1 and 8 (not on the numeric keypad!) will load the corresponding factory default preset. Alt plus number loads the user preset.
- Using multiple Firefaces, clicking the button *Unit 2* while holding down Ctrl opens a second TotalMix window for the second Fireface 800, instead of replacing the window contents.

The faders can also be moved pairwise, corresponding to the stereo-routing settings. This is achieved by pressing the **Alt**-key and is especially comfortable when setting the SPDIF and Phones output level. Even the panoramas can be operated with Alt, from stereo through mono to inversed channels, and also the Mute and Solo buttons (ganged or inversed switching!).

At the same time, TotalMix also supports combinations of these keys. If you press **Ctrl** and **Alt** at the same time, clicking with the mouse makes the faders jump to 0 dB pairwise, and they can be set pairwise by **Shift-Alt** in fine mode.

Also very useful: the faders have two mouse areas. The first area is the fader button, which can be grabbed at any place without changing the current position. This avoids unwanted changes when clicking onto it. The second area is the whole fader setting area. Clicking into this area makes the fader jump to the mouse at once. If for instance you want to set several faders to m.a., it is sufficient to click onto the lower end of the fader path. Which happens pairwise with the Alt-key pressed.

Using the hotkeys **I**, **O** and **P** the complete row of Input, Playback and Output channels each can be toggled between visible and invisible. Hotkey **S** switches Submix view on/off. Those four hotkeys have the same functionality as the buttons in the **View** section of the Quick Access Panel. The Level Meter Setup dialog can be opened via **F2** (as in DIGICheck). The dialog box Preferences is opened via **F3**.

Hotkey **M** toggles Mute Master on/off (and with this performs a global mute on/off). Hotkey **X** toggles the Matrix view on/off (see chapter 30), hotkey **T** the mixer view. Hotkey **L** links all faders as stereo pairs.

Further hotkeys are available to control the configuration of the Level Meter (see chapter 29.15):

Key **4** or **6**: Display range 40 or 60 dB

Key **E** or **R**: Numerical display showing Peak or RMS

Key **0** or **3**: RMS display absolute or relative to 0 dBFS

---

## 29.13 Menu Options

**Always on Top:** When active (checked) the TotalMix window will always be on top of the Windows desktop.

**Note:** This function may result in problems with windows containing help text, as the TotalMix window will even be on top of those windows, so the help text isn't readable.

**Deactivate Screensaver:** When active (checked) any activated Windows screensaver will be disabled temporarily.

**Ignore Position:** When active, the windows size and position stored in a file or preset will not be used. The routing will be activated, but the window will not change.

**Ignore I/O Labels:** When active the channel names saved in a preset or file will not be loaded, instead the current ones will be retained.

**ASIO Direct Monitoring (Windows only):** When de-activated any ADM commands will be ignored by TotalMix. In other words, ASIO Direct Monitoring is globally de-activated.

**Link Faders:** Selecting this option all faders will be treated as stereo pairs and moved pairwise. Hotkey L.

**MS Processing:** Macro for a quick configuration of routing and phase for Mid/Side encoding and decoding. See chapter 31.7.

**Level Meter Setup:** Configuration of the Level Meters. Hotkey F2. See chapter 29.15.

**Level Meter Text Color:** Colour adjustment for the Gain and Level meter text displays. Default: Hue 110, Saturation 225, Brightness 135.

**Preferences:** Opens a dialog box to configure several functions, like Pan Law, Dim, Talkback Dim, Listenback Dim. See chapter 29.10.

**Flash current mixer state:** A click on this entry stores all current mixer settings into the flash memory of the Fireface. See chapter 24, Stand-alone Operation.

**Enable MIDI Control:** Turns MIDI control on. The channels which are currently under MIDI control are indicated by a colour change of the info field below the faders, black turns to yellow.

**Deactivate MIDI in Background:** Disables the MIDI control as soon as another application is in the focus, or in case TotalMix has been minimized.

**Lock Mixer:** Opens a dialog box for password entry. Changes on the mixer have no effect anymore until the mixer is unlocked in the same way, by entering the password a second time. The password is stored unencrypted in the registry (Windows: Software, RME, firefacemix, Password).

**Undo Load Preset:** Turns the mixer state back to the state before the last preset was loaded. This function helps to get back the last mixer setup that was accidentally destroyed by unintentionally loading a preset.

## 29.14 Menu Fader Groups

TotalMix supports 4 different fader groups. Usage:

- Select faders by clicking on the white name label (turns yellow)
- In the menu click on *Define* – Group X. The level meters below the faders now show GrpX.
- Any group can be activated and deactivated in the menu *Activate*
- Any group can be deleted in the menu *Delete*

## 29.15 Level Meter

The Fireface 800 calculates all the display values Peak, Over and RMS in hardware, in order to be capable of using them independent of the software in use, and to significantly reduce the CPU load.

**Tip:** This feature, the **Hardware Level Meter**, is used by **DIGICheck** (see chapter 15/22) to display Peak/RMS level meters of all channels, nearly without any CPU load.

The level meters integrated in TotalMix - considering their size - cannot be compared with DIGICheck. Nevertheless they already include many useful functions.

Peak and RMS is displayed for every channel. 'Level Meter Setup' (menu Options or F2) and direct keyboard entry (*hotkeys*) make various options available:

- Display range 40 or 60 dB (*hotkey 4 or 6*)
- Release time of the Peak display (Fast/Medium/Slow)
- Numerical display selectable either Peak or RMS (*Hotkey E or R*)
- Number of consecutive samples for Overload display (1 to 15)
- RMS display absolute or relative to 0 dBFS (*Hotkey 3 or 0*)

The latter is a point often overlooked, but nonetheless important. A RMS measurement shows 3 dB less for sine signals. While this is mathematically correct, it is not very reasonable for a level meter. Therefore the RMS readout is usually corrected by 3 dB, so that a full scale sine signal shows 0 dBFS on both Peak and RMS meters.

This setting also yields directly readable signal-to-noise values. Otherwise the value shown with noise is 3 dB better than it actually is (because the reference is not 0 dB, but -3 dB).

The value displayed in the text field is independent of the setting 40/60 dB, it represents the full 24 bit range of the RMS measurement. An example: An RME ADI-8 QS connected to the Fireface's ADAT port will show around -114 dBFS on all eight channel's input level meters.



This level display of TotalMix also provides means for a constant monitoring of the signal quality. Thus it can be a valuable tool for sound optimization and error removal in the studio.



*Measuring SNR (Signal to Noise) is best done with RME's free software DIGICheck. The function Bit Statistic includes three different RMS meters for exactly this purpose (RMS unweighted, A-weighted and DC).*

---

## 30. TotalMix: The Matrix

### 30.1 Overview

The mixer window of TotalMix looks and operates similar to mixing desks, as it is based on a conventional stereo design. The matrix display presents a different method of assigning and routing channels, based on a single channel or monaural design. The matrix view of the Fireface 800 has the looks and works like a conventional patchbay, adding functionality way beyond comparable hardware and software solutions. While most patchbays will allow you to connect inputs to outputs with just the original level (1:1, or 0 dB, as known from mechanical patchbays), TotalMix allows you to use a freely definable gain value per crosspoint.

Matrix and TotalMix are different ways of displaying the same processes. Because of this both views are always fully synchronized. Each change in one view is immediately reflected in the other view as well.

### 30.2 Elements of the Matrix View

The visual design of the TotalMix Matrix is mainly determined by the architecture of the Fireface 800:

- Horizontal labels: All hardware outputs
- Vertical labels: All hardware inputs. Below are all playback channels (software playback channels)
- Green 0.0 dB field: Standard 1:1 routing
- Black gain field: Shows the current gain value as dB
- Orange gain field: This routing is muted
- Blue field: Phase 180° (inverted)



	AN 1	AN 2	AN 3	AN 4	AN 5
In 1	0.0				
In 2		-5.9			
In 3			0.0		
In 4					
In 5					0.0
In 6					
In 7					
In 8					
In 9					
In 10					

To maintain overview when the window size has been reduced, the left and upper labels are floating. They won't leave the visible area when scrolling.

### 30.3 Operation

Using the Matrix is a breeze. It is very easy to identify the current crosspoint, because the outer labels light up in orange according to the mouse position.

If input 1 is to be routed to output 1, use the mouse and click one time on crosspoint **In 1 / AN 1**. The green 0.0 dB field pops in, another click removes it. To change the gain (equals the use of a different fader position, see simultaneous display of the mixer view), hold Ctrl down and drag the mouse up or down, starting from the gain field. The value within the field changes accordingly. The corresponding fader in the mixer view is moving simultaneously, in case the currently modified routing is visible.

Note the difference between the left side, representing the inputs and software playback channels, and the upper side, representing the hardware outputs.

A gain field marked orange indicates activated mute status. Mute can only be changed in the mixer view.

---

A blue field indicates phase inversion. This state is displayed in the Matrix only, and can only be changed within the Matrix view. Hold down the Shift-key while clicking on an already activated field. Mute overwrites the phase display, blue becomes orange. If mute is deactivated the phase inversion is indicated again.

## 30.4 Advantages of the Matrix

The Matrix not always replaces the mixer view, but it significantly enhances the routing capabilities and - more important - is a brilliant way to get a fast overview of all active routings. It shows you in a glance what's going on. And since the Matrix operates monaural, it is very easy to set up specific routings with specific gains.

**Example 1:** You want TotalMix to route all software outputs to all corresponding hardware outputs, and have a submix of all inputs and software outputs on the Phones output (equals factory preset 2). Setting up such a submix is easy. But how to check at a later time, that all settings are still exactly the way you wanted them to be, not sending audio to a different output?

The most effective method to check a routing in mixer view is the Submix View, stepping through all existing software outputs, and having a very concentrated look at the faders and displayed levels of each routing. That doesn't sound comfortably nor error-free, right? Here is where the Matrix shines. In the Matrix view, you simply see a line from upper left to lower right, all fields marked as unity gain. Plus two rows vertically all at the same level setting. You just need 2 seconds to be sure no unwanted routing is active anywhere, and that all levels match precisely!

**Example 2:** The Matrix allows you to set up routings which would be nearly impossible to achieve by fiddling around with level and pan. Let's say you want to send input 1 to output 1 at 0 dB, to output 2 at -3 dB, to output 3 at -6 dB and to output 4 at -9 dB. Each time you set up the right channel (2/4), the change in pan destroys the gain setting of the left channel (1/2). A real hassle! In Matrix view, you simply click on the corresponding routing point, set the level via Ctrl-mouse, and move on. You can see in TotalMix view how pan changes to achieve this special gain and routing when performing the second (fourth...) setting.

## 31. TotalMix Super-Features

### 31.1 ASIO Direct Monitoring (Windows only)

Start Samplitude, Sequoia, Cubase or Nuendo and TotalMix. Activate ADM (ASIO Direct Monitoring), and move a fader in the ASIO host. Now watch the corresponding fader in TotalMix magically move too. TotalMix reflects all ADM gain and pan changes in real-time. Please note that faders only move when the currently activated routing (currently visible routing) corresponds to the one in the ASIO host. Also note that the Matrix will show any change, as it shows all possible routings in one view.

With this TotalMix has become a wonderful debugging tool for ADM. Just move the host's fader and pan, and see what kind of ADM commands TotalMix receives.

The hardware output row faders are included in all gain calculations, in every possible way. Example: you have lowered the output level of a submix, or just a specific channel, by some dB. The audio signal passed through via ADM will be attenuated by the value set in the third row.

---

## 31.2 Selection and Group-based Operation

Click on the white name label of channel 1 and 2 in TotalMix. Be sure to have channel 3's fader set to a different position and click on its label too. All three labels have changed to the colour orange, which means they are *selected*. Now moving any of these faders will make the other faders move too. This is called 'building a group of faders', or ganging faders, maintaining their relative position.

Building groups or ganging can be done in any row, but is limited to operate horizontally within one row. If you usually don't need this, you can at least gang the analog outputs. The advantage over holding the Alt-key is that Alt sets both channels to the same level (can be handy too), while grouping via selection will retain any offset (if you need one channel to be louder all the time etc.).

Note: The relative positions are memorized until the faders are pulled down so that they reach upper or lower maximum position *and* the group is changed (select another channel or deselect one of the group).

## 31.3 Copy Routings to other Channels

TotalMix allows to copy complete routing schemes of inputs and outputs.

**Example 1:** You have input 1 (guitar) routed within several submixes/hardware outputs (= headphones). Now you'll get another input with keyboards that should appear in the same way on all headphones. Select input 1, open the menu *Edit*. It shows 'Copy In 1'. Now select the desired new input, for example In 8. The menu now shows 'Paste In 1 to In 8'. Click on it - done. If you are familiar with this functionality just use Ctrl-C and Ctrl-V. Else the self updating menu will always let you know what actually will happen.

Tip: Have the Matrix window open as second window when doing this. It will show the new routings immediately, so copying is easier to understand and to follow.

**Example 2:** You have built a comprehensive submix on outputs 4/5, but now need the exact same signal also on the outputs 6/7. Click on Out 4, Ctrl-C, click on Out 6, Ctrl-V, same with 5/7 - you're done!

The Matrix shows you the difference between both examples. Example 1 means copying lines (horizontally), while example 2 means copying rows (vertically).

**Example 3:** Let's say the guitarist finished his recording, and you now need the same signal again on all headphones, but this time it comes from the recording software (playback row). No problem, you can even copy between rows 1 and 2 (copying between row 3 and 1/2 isn't possible).

But how to select while a group is active? De-selecting the group first? Not necessary! TotalMix always updates the copy and paste process with the *last* selection. This way you don't have to de-activate any group-selections when desiring to perform a copy and paste action.

## 31.4 Delete Routings

The fastest way to delete complex routings: select a channel in the mixer view, click on the menu entry *Edit* and select *Delete*. Or simply hit the Del-key. Attention: there is no undo in TotalMix, so be careful with this function!

### 31.5 Recording a Subgroup (Loopback)

TotalMix supports a routing of the subgroup outputs (=hardware outputs, bottom row) to the recording software. Instead of the signal at the hardware input, the signal at the hardware output is sent to the record software. This way, complete submixes can be recorded without an external loopback cable. Also the playback of a software can be recorded by another software.

To activate this function, click on the grey label in the third row while holding down the Ctrl-key. The label's colour changes to red. In case the channel has already been part of a group, the colour will change from yellow to orange, signalling that the group functionality is still active for this channel.

In loopback mode, the signal at the hardware input of the corresponding channel is no longer sent to the recording software, but still passed through to TotalMix. Therefore TotalMix can be used to route this input signal to any hardware output. Using the subgroup recording, the input can still be recorded on a different channel.

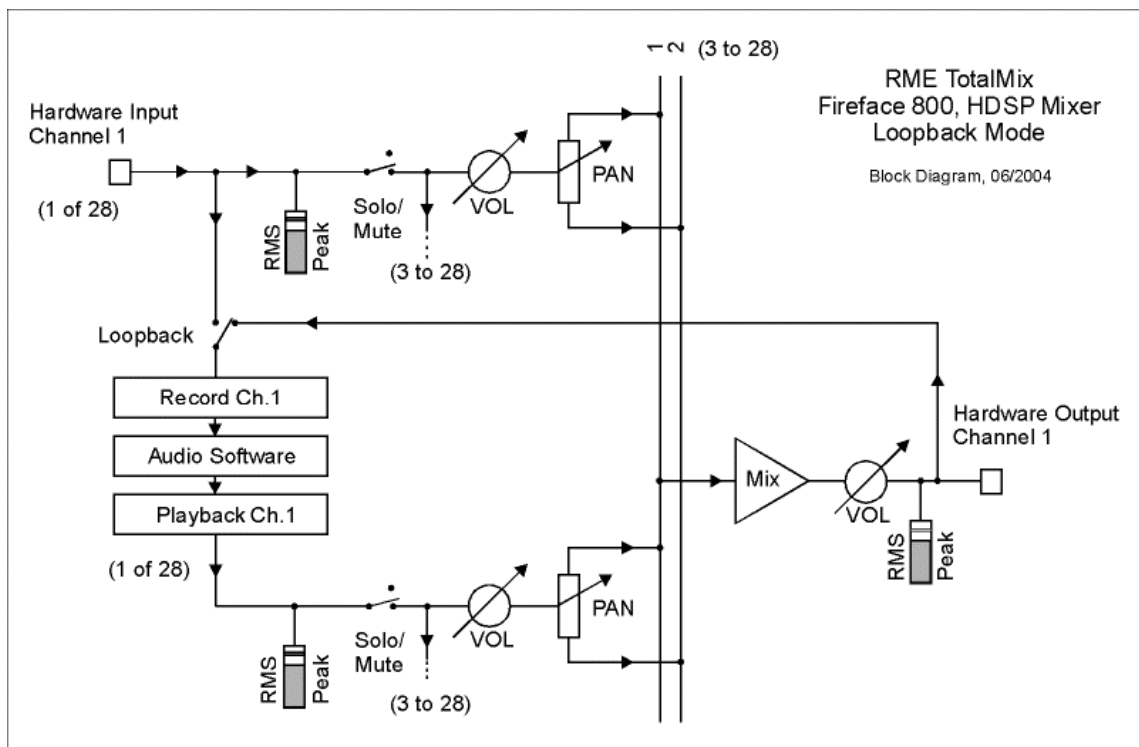

As each of the 28 hardware outputs can be routed to the record software, and none of these hardware inputs get lost, TotalMix offers an overall flexibility and performance not rivalled by any other solution.

Additionally the risk of feedbacks, a basic problem of loopback methods, is highly reduced, because the feedback can not happen within the mixer, but only when the audio software is switched into monitoring mode. The block diagram shows how the software's input signal is played back, and fed back from the hardware output to the software input. A software monitoring on the subgroup record channels is only allowed as long as the monitoring is routed in both software and TotalMix to a different channel than the active subgroup recording one.

---

### Recording a Software's playback

In real world application, recording a software's output with another software will show the following problem: The record software tries to open the same playback channel as the playback software (already active), or the playback one has already opened the input channel which should be used by the record software.

This problem can easily be solved. First make sure that all rules for proper multi-client operation are met (not using the same record/playback channels in both programs). Then route the playback signal via TotalMix to a hardware output in the range of the record software, and activate it via Ctrl-mouse for recording.

### Mixing several input signals into one record channel

In some cases it is useful to record several sources in only one track. For example when using two microphones when recording instruments and loudspeakers, TotalMix' Loopback mode saves an external mixing desk. Simply route/mix the input signals to the same output (third row), then re-define this output into a record channel via Ctrl-mouse – that's it. This way any number of input channels from different sources can be recorded into one single track.

## 31.6 Using external Effects Devices

With TotalMix a usage of external hardware - like effects devices - is easy and flexible.

**Example 1:** The singer (microphone input channel 10) shall have some reverb on his headphones (outputs 9/10). A direct routing In 10 to Out 9/10 for monitoring had been set up already. The external reverb is connected to a free output, for example channel 8. In active mode Submix View click on channel 8 in the bottom row. Drag the fader of input 10 to about 0 dB and the panorama fully to the right. Adjust the input level at the reverb unit to an optimal setting. Next the output of the reverb unit is connected to a free stereo input, for example 5/6. Use the TotalMix level meters to adjust a matching output level at the reverb unit. Now click on channels 9/10 in the bottom row, and move the fader of inputs 5/6 until the reverb effect gets a bit too loud in the headphones. Now click on channel 8 in the bottom row again and drag fader 10 down a bit until the mix of original signal and reverb is perfect for the singer.

The described procedure is completely identical to the one when using an analog mixing desk. There the signal of the singer is sent to an output (usually labelled Aux), from there to a reverb unit, sent back from the reverb unit as stereo wet signal (no original sound), back in through a stereo input (e.g. Effect return) and mixed to the monitoring signal. The only difference: The Aux sends on mixing desks are post-fader. Changing the level of the original signal causes a change of the effects level (here the reverb) too, so that both always have the same ratio.

**Tip:** Such functionality is available in TotalMix via the right mouse button! Dragging the faders by use of the right mouse button causes all routings of the current input or playback channel to be changed in a relative way. This completely equals the function Aux post fader.

**Example 2:** Inserting an effects device can be done as above, even within the record path. Other than in the example above the reverb unit also sends the original signal, and there is no routing of input 10 directly to outputs 9/10. To insert an effects device like a Compressor/Limiter directly into the record path, the input signal of channel 10 is sent by TotalMix to any output, to the Compressor, back from the Compressor to any input. This input is now selected within the record software.



Unfortunately, very often it is not possible within the record software to assign a different input channel to an existing track 'on the fly'. The loopback mode solves this problem elegantly. The routing scheme stays the same, with the input channel 10 sent to any output via TotalMix, to the Compressor, from the Compressor back to any input. Now this input signal is routed directly to output 10, and output 10 is then switched into loopback mode via Ctrl-mouse.

As explained in chapter 31.5, the hardware input of channel 10 now no longer feeds the record software, but is still connected to TotalMix (and thus to the Compressor). The record software receives the signal of submix channel 10 instead – the Compressor's return path.

### 31.7 MS Processing

The mid/side principle is a special positioning technique for microphones, which results in a mid signal on one channel and a side signal on the other channel. These information can be transformed back into a stereo signal quite easily. The process sends the monaural mid channel to left and right, the side channel too, but phase inverted (180°) to the right channel. For a better understanding: the mid channel represents the function L+R, while the side channel represents L-R.

During record the monitoring needs to be done in 'conventional' stereo. As TotalMix can invert the phase, it also offers the functionality of a M/S-decoder. The menu *Options* includes a macro to simplify the setup. First select the two input channels, in the picture to the right *Analog In 3* and *4*, having the current routing destination *Analog Out 1+2*. Now the string *MS Processing In 3+4 to AN 1+2 On* is shown in *Options*.

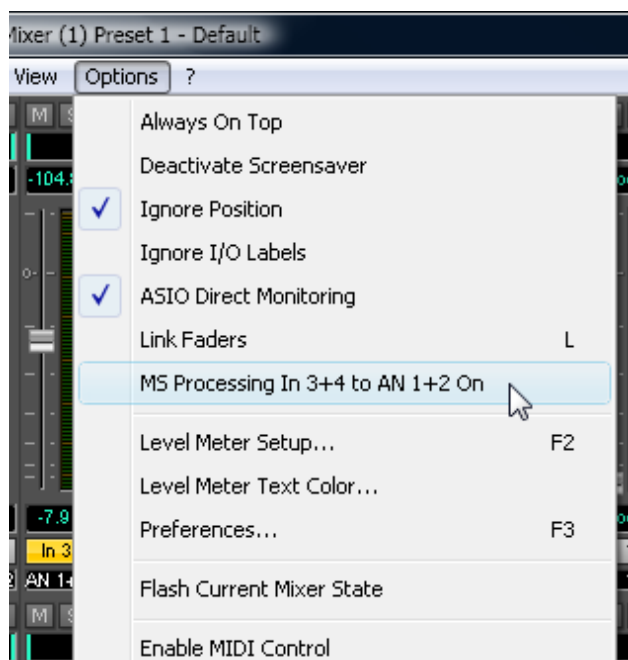

	AN 1	AN 2	AN 3
In 1			
In 2			
In 3	-6.0	-6.0	
In 4	-6.0	-6.0	
In 5			
In 6			
In 7			

After a mouse click TotalMix sets gains and pans correctly. Of course these settings can also be performed manually. Repeat the last step to remove all routings (*menu Options ...Off*).

The M/S-Processing automatically operates as M/S encoder or decoder, depending on the source signal format. When processing a usual stereo signal, all monaural information will be shifted into the left channel, all stereo information into the right channel. Thus the stereo signal is M/S encoded. This yields some interesting insights into the mono/stereo contents of modern music productions. Additionally some very interesting methods of manipulating the stereo base and generating stereo effects come up, as it is then very easy to process the side channel with Low Cut, Expander, Compressor or Delay. The most basic application is already available directly in TotalMix: Changing the level of the side channel allows to manipulate the stereo width from mono to stereo up to extended, stepless and in real-time.

---

## 32. MIDI Remote Control

### 32.1 Overview

TotalMix can be remote controlled via MIDI. It is compatible to the widely spread Mackie Control protocol, so TotalMix can be controlled with all hardware controllers supporting this standard. Examples are the Mackie Control, Tascam US-2400 or Behringer BCF 2000.

Additionally, the stereo output faders (lowest row) which are set up as *Monitor Main* outputs in the Monitor panel can also be controlled by the standard **Control Change Volume** via **MIDI channel 1**. With this, the main volume of the Fireface is controllable from nearly any MIDI equipped hardware device.

### 32.2 Mapping

TotalMix supports the following Mackie Control surface elements\*:

Element:	Meaning in TotalMix:
Channel faders 1 – 8	volume
Master fader	Main Monitor channel's faders
SEL(1-8) + DYNAMICS	reset fader to Unity Gain
V-Pots 1 – 8	pan
pressing V-Pot knobs	pan = center
CHANNEL LEFT or REWIND	move one channel left
CHANNEL RIGHT or FAST FORWARD	move one channel right
BANK LEFT or ARROW LEFT	move eight channels left
BANK RIGHT or ARROW RIGHT	move eight channels right
ARROW UP or Assignable1/PAGE+	move one row up
ARROW DOWN or Assignable2/PAGE-	move one row down
EQ	Master Mute
PLUGINS/INSERT	Master Solo
STOP	Dim Main Monitor
PLAY	Talkback
PAN	Mono Main Monitor
MUTE Ch. 1 – 8	Mute
SOLO Ch. 1 – 8	Solo
SELECT Ch. 1 – 8	Select
REC Ch. 1 – 8	in Submix mode only: select output bus
F1 - F8	load preset 1 - 8
F9	select Main Monitor
F10 - F12	Monitor Phones 1 - 3

\*Tested with Behringer BCF2000 Firmware v1.07 in Mackie Control emulation for Steinberg mode and with Mackie Control under Mac OS X.

---

## 32.3 Setup

- Open the Preferences dialog (menu Options or F3). Select the MIDI Input and MIDI Output port where your controller is connected to.
- When no feedback is needed (when using only standard MIDI commands instead of Mackie Control protocol) select NONE as MIDI Output.
- Check *Enable MIDI Control* in the Options menu.

## 32.4 Operation

The channels being under MIDI control are indicated by a colour change of the info field below the faders, black turns to yellow.

The 8-fader block can be moved horizontally and vertically, in steps of one or eight channels.

Faders can be selected to gang them.

In Submix View mode, the current routing destination (output bus) can be selected via REC Ch. 1 – 8. This equals the selection of a different output channel in the lowest row by a mouse click when in Submix View. In MIDI operation it is not necessary to jump to the lowest row to perform this selection. This way even the routing can be easily changed via MIDI.

*Full LC Display Support.* This option in Preferences (F3) activates complete Mackie Control LCD support with eight channel names and eight volume/pan values.



*Attention: this feature causes heavy overload of the MIDI port when ganging more than 2 faders! In such a case, or when using the Behringer BCF2000, turn off this option.*

When *Full LC Display Support* is turned off, only a brief information about the first fader of the block (channel and row) is sent. This brief information is also available on the LED display of the Behringer BCF2000.

*Deactivate MIDI in Background* (menu Options) disables the MIDI control as soon as another application is in the focus, or in case TotalMix has been minimized. This way the hardware controller will control the main DAW application only, except when TotalMix is in the foreground. Often the DAW application can be set to become inactive in background too, so that MIDI control is switched between TotalMix and the application automatically when switching between both applications.

TotalMix also supports the 9th fader of the Mackie Control. This fader (labelled Master) will control the stereo output faders (lowest row) which are set up as *Main Monitor* outputs in the Monitor panel. Always and only.

---

## 32.5 Simple MIDI Control

The stereo output faders (lowest row) which are set up as *Monitor Main* outputs in the Monitor panel can also be controlled by the standard **Control Change Volume** via **MIDI channel 1**. With this, the main volume of the Fireface is controllable from nearly any MIDI equipped hardware device.

Even if you don't want to control all faders and pans, some buttons are highly desired to be available in 'hardware'. These are mainly the *Talkback* and the *Dim* button, and the new monitoring options (listen to Phones submixes). Fortunately a Mackie Control compatible controller is not required to control these buttons, as they are steered by simple Note On/Off commands on MIDI channel 1.

The notes are (hex / decimal / keys):

**Monitor Main:** 3E / 62 / **D 4**

**Dim:** 5D / 93 / **A 6**

**Mono:** 2A / 42 / **#F 2**

**Talkback:** 5E / 94 / **#A 6**

**Monitor Phones 1:** 3F / 63 / **#D 4**

**Monitor Phones 2:** 40 / 64 / **E 4**

**Monitor Phones 3:** 41 / 65 / **F 4**

**Preset 1:** 36 / 54 / **#F 3**

**Preset 2:** 37 / 55 / **G 3**

**Preset 3:** 38 / 56 / **#G 3**

**Preset 4:** 39 / 57 / **A 3**

**Preset 5:** 3A / 58 / **#A 3**

**Preset 6:** 3B / 59 / **B 3**

**Preset 7:** 3C / 60 / **C 4**

**Preset 8:** 3D / 61 / **#C 4**

Note: Switching off Mackie Protocol support in *Preferences / Mackie Control Options* will also disable the above simple MIDI note commands, as they are part of the Mackie protocol.

Furthermore TotalMix allows to control all faders of all three rows via simple **Control Change** commands.

The format for the Control Change commands is:

Bx yy zz

x = MIDI channel

yy = control number

zz = value

The first row in TotalMix is addressed by MIDI channels 1 up to 4, the middle row by channels 5 up to 8 and the bottom row by channels 9 up to 12.

16 Controller numbers are used: 102 up to 117 (= hex 66 to 75).

With these 16 Controllers (= faders) and 4 MIDI channels each per row, up to 64 faders can be controlled per row (as required by the HDSPe MADI).

---

Examples for sending MIDI strings:

- Set input 1 to 0 dB: B0 66 64
- Set input 17 to maximum attenuation: B1 66 0
- Set playback 1 to maximum: B4 66 7F
- Set Output 16 to 0 dB: B8 75 64

Note: Sending MIDI strings requires the use of programmer's logic for the MIDI channel, starting with 0 for channel 1 and ending with 15 for channel 16.

### 32.6 Loopback Detection

The Mackie Control protocol requires feedback of the received commands, back to the hardware controller. So usually TotalMix will be set up with both a MIDI input and MIDI output. Unfortunately any small error in wiring and setup will cause a MIDI feedback loop here, which then completely blocks the computer (the CPU).

To prevent the computer from freezing, TotalMix sends a special MIDI note every 0.5 seconds to its MIDI output. As soon as it detects this special note at the input, the MIDI functionality is disabled. After fixing the loopback, check *Enable MIDI Control* under Options to reactivate the TotalMix MIDI.

---

## 32.7 Stand-Alone MIDI Control

When not connected to a computer, the Fireface 800 can be controlled **directly** via MIDI. To unlock the special **stand-alone MIDI control mode** first activate MIDI control in TotalMix (*Enable MIDI control*), then transfer this state via *Flash current mixer state* into the unit. Turning this mode off is done in the same way, but with MIDI control deactivated.

**Note:** When not needed the stand-alone MIDI operation should not be active, as the unit will react on MIDI notes after power-on, and will also send MIDI notes.

Control is performed via both the **Mackie Control protocol** and some **standard** MIDI functions (see below). In stand-alone mode not all functions known from TotalMix are available, because some of them aren't hardware, but software routines. Functions like *Talkback*, *DIM*, *Mono*, *Solo*, *relative* ganging of the faders, *Monitor Main* and *Monitor Phones* are realized by complex software code, therefore not available in stand-alone MIDI control operation.

Still many functions, and especially the most important functions to control the Fireface 800, are implemented in hardware, thus available also in stand-alone mode:

- All faders and pans of the first and third row
- Mute of the input signal per channel
- Ganging via 'Select'
- Choice of the routing destination, i.e. the current submix
- Sending of LED and display data to the MIDI controller

The second row (software playback) is skipped in stand-alone operation.

The Fireface 800 sends display data as brief information, enabling an easy navigation through lines and rows. Other data like PAN and miscellaneous status LEDs are supported as well.

In stand-alone mode the unit always operates in **View Submix** mode. Only this way the routing destination can be changed, and several mixdowns/submixes can be set up quickly and easily. If the current TotalMix setup is transferred into the Fireface via 'Flash current mixer state', the currently selected submix output is also pre-configured in the hardware for stand-alone MIDI remote operation.

### Mackie Control Protocol

The stand-alone operation supports the following Mackie Control surface elements\*:

\*Tested with Behringer BCF2000 Firmware v1.07 in Mackie Control emulation for Steinberg mode.

Element:	Meaning in Fireface:
Channel faders 1 – 8	volume
SEL(1-8) + DYNAMICS	reset fader to Unity Gain
V-Pots 1 – 8	pan
pressing V-Pot knobs	pan = center
CHANNEL LEFT or REWIND	move one channel left
CHANNEL RIGHT or FAST FORWARD	move one channel right
BANK LEFT or ARROW LEFT	move eight channels left
BANK RIGHT or ARROW RIGHT	move eight channels right
ARROW UP or Assignable1/PAGE+	move one row up
ARROW DOWN or Assignable2/PAGE-	move one row down
EQ	Master Mute
MUTE Ch. 1 – 8	Mute
SELECT Ch. 1 – 8	Select
REC Ch. 1 – 8	select output bus (current submix)

---

In stand-alone MIDI mode, the Mackie Control protocol also gives access to some settings of the **Settings dialog**:

<b>Element:</b>	<b>Meaning in Fireface:</b>
SOLO Ch. 1	Input Level Lo Gain
SOLO Ch. 2	Input Level +4 dBu
SOLO Ch. 3	Input Level -10 dBV
SOLO Ch. 4	Output Level Hi Gain
SOLO Ch. 5	Output Level +4 dBu
SOLO Ch. 6	Output Level -10 dBV
SOLO Ch. 7	Clock Mode AutoSync
SOLO Ch. 8	Clock Mode Master
F9	Phantom Power Mic 7
F10	Phantom Power Mic 8
F11	Phantom Power Mic 9
F12	Phantom Power Mic 10
F13	Instrument Options Drive
F14	Instrument Options Limiter
F15	Instrument Options Speaker Emulation

### **Simple MIDI Control**

Several important faders can be controlled in stand-alone MIDI mode using the standard **Control Change Volume** (CC 07) and **Control Change Pan** (CC 10). With this, the most important volume settings of the Fireface are controllable from nearly any MIDI equipped hardware device.

The faders are controlled via different MIDI channels:

#### **Hardware Output** (equals third row, volume only)

Analog Out 9+10 (Phones)	MIDI channel 1
Analog Out 1+2	MIDI channel 16

#### **Hardware Input** (equals first row, volume and pan)

Input channel 1	MIDI channel 2
Input channel 2	MIDI channel 3
Input channel 3	MIDI channel 4
Input channel 4	MIDI channel 5
Input channel 5	MIDI channel 6
Input channel 6	MIDI channel 7
Input channel 7	MIDI channel 8
Input channel 8	MIDI channel 9
Input channel 9	MIDI channel 10
Input channel 10	MIDI channel 11
Input channel 11	MIDI channel 12
Input channel 12	MIDI channel 13
Input channel 13	MIDI channel 14
Input channel 14	MIDI channel 15





---

## User's Guide



# Fireface 800

► **Technical Reference**

---

## 33. TECH INFO

Not all information to and around our products fit in a manual. Therefore RME offers a lot more and detailed information in the **Tech Infos** on our website, section Support. These are some of the currently available *Tech Infos*:

FireWire Audio by RME – Technical Background  
FireWire 800 Hardware – Compatibility Problems  
FireWire 800 under Windows XP SP2

Driver updates Fireface 800 – Lists all changes of the driver updates.

SteadyClock: RME's new clock technology in theory and operation

DIGICheck: Analysis, tests and measurements with RME audio hardware  
A description of DIGICheck, including technical background information.

HDSP System: TotalMix - Hardware and Technology  
Background information on the digital mixer of the Hammerfall DSP/Fireface

Synchronization II (DIGI96 series)  
Digital audio synchronization - technical background and pitfalls.

Installation problems - Problem descriptions and solutions.

ADI-8 Inside  
Technical information about the RME ADI-8 (24-bit AD/DA converter).

HDSP System: Notebook Basics - Notebook Hardware  
HDSP System: Notebook Basics - The Audio Notebook in Practice  
HDSP System: Notebook Basics - Background Knowledge and Tuning  
HDSP System: Notebook Tests - Compatibility and Performance  
Many background information on laptops. Tests of notebooks.

---

## 34. Technical Specifications

### 34.1 Analog

#### AD, Line In 1-8, rear

- Resolution AD: 24 bit
- Signal to Noise ratio (SNR): 110 dB RMS unweighted, 113 dBA
- Frequency response @ 44.1 kHz, -0.1 dB: 5 Hz – 20.6 kHz
- Frequency response @ 96 kHz, -0.5 dB: 5 Hz – 45.3 kHz
- Frequency response @ 192 kHz, -1 dB: 5 Hz - 90 kHz
- THD: < -110 dB, < 0.00032 %
- THD+N: < -104 dB, < 0.00063 %
- Channel separation: > 110 dB
- Maximum input level: +19 dBu
- Input: 6.3 mm TRS jack, electronically balanced
- Input impedance: 10 kOhm
- Input sensitivity switchable to Lo Gain, +4 dBu, -10 dBV
- Input level for 0 dBFS @ Lo Gain: +19 dBu
- Input level for 0 dBFS @ +4 dBu: +13 dBu
- Input level for 0 dBFS @ -10 dBV: +2 dBV
- Mute: 100 dB

#### Line In 7-10, Front

- as AD, but:
- Gain range (via pot): 50 dB
- Maximum input level, Gain 10 dB: +22 dBu
- Maximum input level, Gain 60 dB: -28 dBu
- CLIP LED: -2 dBFS
- SIG LED: -45 dBFS
- Mute: > 130 dB

#### Microphone

- as AD, but:
- Input: XLR, electronically balanced
- Input impedance: 2 kOhm
- Gain range (via pot): 50 dB
- Maximum input level, Gain 10 dB: +11 dBu
- Maximum input level, Gain 60 dB: -39 dBu
- CLIP LED: -2 dBFS
- SIG LED: -45 dBFS
- Mute: > 130 dB

#### Instrument

- as AD, but:
- Input: 6.3 mm TS jack, unbalanced
- Input impedance: 470 kOhm
- Signal to Noise ratio (SNR): 108 dB RMS unweighted, 111 dBA
- Gain range (via pot): 52 dB
- Drive Gain: 23 dB
- Maximum input level, Gain 1, -10 dBFS: +10 dBu
- Maximum input level, Gain 9, -10 dBFS: -42 dBu
- LIM LED: -10 dBFS
- SIG LED: -40 dBFS
- Mute: > 120 dB

---

### **DA, Line Out 1-8, rear**

- Resolution: 24 bit
- Dynamic range (DR): 116 dB, 119 dBA @ 44.1 kHz (unmuted)
- Frequency response @ 44.1 kHz, -0.1 dB: 1 Hz – 20.1 kHz
- Frequency response @ 96 kHz, -0.5 dB: 1 Hz – 43.5 kHz
- Frequency response @ 192 kHz, -1 dB: 1 Hz - 70 kHz
- THD: -103 dB, < 0.0007 %
- THD+N: -100 dB, < 0.001 %
- Channel separation: > 110 dB
- Maximum output level: +19 dBu
- Output: 6.3 mm TRS jack, servo-balanced
- Output impedance: 75 Ohm
- Output level switchable Hi Gain, +4 dBu, -10 dBV
- Output level at 0 dBFS @ Hi Gain: +19 dBu
- Output level at 0 dBFS @ +4 dBu: +13 dBu
- Output level at 0 dBFS @ -10 dBV: +2 dBV

### **DA - Stereo Monitor Output (Phones)**

- as DA, but:
- Output: 6.3 mm TRS jack, unbalanced (stereo)
- Maximum output level at 0 dBFS: +17 dBu
- Output impedance: 30 Ohm

## **34.2 MIDI**

- 1 x MIDI I/O via 5-pin DIN jacks
- Galvanically isolated by optocoupled input
- Hi-speed mode: Jitter and response time typically below 1 ms
- Separate 128 byte FIFOs for input and output

## **34.3 Digital**

- Clocks: Internal, ADAT In, SPDIF In, word clock in. Optional LTC/Video in
- Low Jitter Design: < 1 ns in PLL mode, all inputs
- Internal clock: 800 ps Jitter, Random Spread Spectrum
- Jitter suppression of external clocks: > 30 dB (2.4 kHz)
- Effective clock jitter influence on AD and DA conversion: near zero
- PLL ensures zero dropout, even at more than 100 ns jitter
- Digital Bitclock PLL for trouble-free varispeed ADAT operation
- Supported sample rates: 28 kHz up to 200 kHz

---

## 34.4 Digital Inputs

### AES/EBU - SPDIF

- 1 x RCA, transformer-balanced, galvanically isolated, according to AES3-1992
- High-sensitivity input stage (< 0.3 Vpp)
- SPDIF compatible (IEC 60958)
- Accepts Consumer and Professional format, copy protection will be ignored
- Lock Range: 27 kHz – 200 kHz
- Jitter when synced to input signal: < 1 ns
- Jitter suppression: > 30 dB (2.4 kHz)

### ADAT Optical

- 2 x TOSLINK
- Standard: 16 channels 24 bit, up to 48 kHz
- Sample Split (S/MUX): 2 x 8 channels 24 bit / 48 kHz, equalling 8 channels 24 bit 96 kHz
- Bitclock PLL ensures perfect synchronisation even in varispeed operation
- Lock Range: 31.5 kHz – 50 kHz
- Jitter when synced to input signal: < 1 ns
- Jitter suppression: > 30 dB (2.4 kHz)

### Word Clock

- BNC, not terminated (10 kOhm)
- Switch for internal termination 75 Ohm
- Automatic Double/Quad Speed detection and internal conversion to Single Speed
- SteadyClock guarantees super low jitter synchronization even in varispeed operation
- Transformer coupled, galvanically isolated input
- Not affected by DC-offsets within the network
- Signal Adaptation Circuit: signal refresh through auto-center and hysteresis
- Overvoltage protection
- Level range: 1.0 Vpp – 5.6 Vpp
- Lock Range: 27 kHz – 200 kHz
- Jitter when synced to input signal: < 1 ns
- Jitter suppression: > 30 dB (2.4 kHz)

---

## 34.5 Digital Outputs

### AES/EBU - SPDIF

- 1 x RCA, transformer-balanced, galvanically isolated, according to AES3-1992
- Output level Professional 2.6 Vpp, Consumer 1.2 Vpp
- Format Professional according to AES3-1992 Amendment 4
- Format Consumer (SPDIF) according to IEC 60958
- Single Wire mode, sample rate 28 kHz up to 200 kHz

### ADAT

- 2 x TOSLINK
- Standard: 16 channels 24 bit, up to 48 kHz
- Sample Split (S/MUX): 2 x 8 channels 24 bit / 48 kHz, equalling 8 channels 24 bit 96 kHz
- In Quad Speed mode output of Single Speed sync frame

### Word Clock

- BNC
- Max. output voltage: 5 Vpp
- Output voltage @ 75 Ohm termination: 4.0 Vpp
- Output impedance: 10 Ohm
- Frequency range: 27 kHz – 200 kHz

## 34.6 General

- Power supply: Internal switching PSU, 100 - 240 V AC, 30 Watt
- Typical power consumption: 22 Watt
- Dimensions including rack ears (WxHxD): 483 x 44 x 242 mm (19" x 1.73" x 9.5")
- Dimensions without rack ears/handles (WxHxD): 436 x 44 x 235 mm (17.2" x 1.73" x 9.3")
- Weight: 3 kg ( 6.6 lbs)
- Temperature range: +5° up to +50° Celsius (41° F up to 122°F)
- Relative humidity: < 75%, non condensing

---

## 35. Technical Background

### 35.1 Lock and SyncCheck

Digital signals consist of a carrier and the data. If a digital signal is applied to an input, the receiver has to synchronize to the carrier clock in order to read the data correctly. To achieve this, the receiver uses a PLL (Phase Locked Loop). As soon as the receiver meets the exact frequency of the incoming signal, it is locked. This **Lock** state remains even with small changes of the frequency, because the PLL tracks the receiver's frequency.

If an ADAT or SPDIF signal is applied to the Fireface 800, the corresponding input LED starts flashing. The unit indicates LOCK, i. e. a valid input signal (in case the signal is also in sync, the LED is constantly lit, see below).

Unfortunately, LOCK does not necessarily mean that the received signal is correct with respect to the clock which processes the read out of the embedded data. Example [1]: The Fireface is set to 44.1 kHz internally (clock mode Master), and a mixing desk with ADAT output is connected to input ADAT1. The corresponding LED will show LOCK immediately, but usually the mixing desk's sample rate is generated internally (also Master), and thus slightly higher or lower than the Fireface's internal sample rate. Result: When reading out the data, there will frequently be read errors that cause clicks and drop outs.

Also when using multiple inputs, a simple LOCK is not sufficient. The above described problem can be solved elegantly by setting the Fireface from Master to AutoSync (its internal clock will then be the clock delivered by the mixing desk). But in case another, un-synchronous device is connected, there will again be a slight difference in the sample rate, and therefore clicks and drop outs.

In order to display those problems optically at the device, the Fireface includes **SyncCheck**. It checks all clocks used for *synchronicity*. If they are not synchronous to each other (i. e. absolutely identical), the SYNC LED of the asynchronous input flashes. In case they are completely synchronous, all LEDs are constantly lit. In example 1 it would have been obvious that the LED ADAT 1 kept on flashing after connecting the mixing desk.

In practice, SyncCheck allows for a quick overview of the correct configuration of all digital devices. So one of the most difficult and error-prone topics of the digital studio world finally becomes easy to handle.

The same information is presented in the Fireface's Settings dialog. In the status display *SyncCheck* the state of all clocks is decoded and shown as simple text (No Lock, Lock, Sync).

---

## 35.2 Latency and Monitoring

The term **Zero Latency Monitoring** has been introduced by RME in 1998 for the DIGI96 series of audio cards. It stands for the ability to pass-through the computer's input signal at the interface directly to the output. Since then, the idea behind has become one of the most important features of modern hard disk recording. In the year 2000, RME published two ground-breaking Tech Infos on the topics *Low Latency Background*, which are still up-to-date: *Monitoring, ZLM and ASIO*, and *Buffer and Latency Jitter*, both found on the RME website.

### How much Zero is Zero?

From a technical view there is no zero. Even the analog pass-through is subject to phase errors, equalling a delay between input and output. However, delays below certain values can subjectively be claimed to be a zero-latency. This applies to analog routing and mixing, and in our opinion also to RME's Zero Latency Monitoring. The term describes the digital path of the audio data from the input of the interface to its output. The digital receiver of the Fireface 800 can't operate un-buffered, and together with TotalMix and the output via the transmitter, it causes a typical delay of 3 samples. At 44.1 kHz this equals about 68  $\mu$ s (0.000068 s), at 192 kHz only 15  $\mu$ s. The delay is valid for ADAT and SPDIF in the same way.

### Oversampling

While the delays of digital interfaces can be disregarded altogether, the analog inputs and outputs do cause a significant delay. Modern converter chips operate with 64 or 128 times oversampling plus digital filtering, in order to move the error-prone analog filters away from the audible frequency range as far as possible. This typically generates a delay of one millisecond. A playback and re-record of the same signal via DA and AD (loopback) then causes an offset of the newly recorded track of about 2 ms. The exact delays of the Fireface 800 are:

Sample frequency kHz	44.1	48	88.2	96	176.4	192
AD (43.2 x 1/fs) ms	0.98	0.9	0.49	0.45		
AD (38.2 x 1/fs) ms					0.22	0.2
DA (28 x 1/fs) ms	0.63	0.58	0.32	0.29	0.16	0.15

### Buffer Size (Latency)

*Windows:* This option found in the Settings dialog defines the size of the buffers for the audio data used in ASIO and WDM (see chapter 13).

*Mac OS X:* The buffer size is defined within the application. Only some do not offer any setting. For example iTunes is fixed to 512 samples.

*General:* A setting of 64 samples at 44.1 kHz causes a latency of 1.5 ms, for record and playback each. But when performing a digital loopback test no latency/offset can be detected. The reason is that the software naturally knows the size of the buffers, therefore is able to position the newly recorded data at a place equalling a latency-free system.

*AD/DA Offset under ASIO and OS X:* ASIO (Windows) and Core Audio (Mac OS X) allow for the signalling of an offset value to correct buffer independent delays, like AD- and DA-conversion or the Safety Buffer described below. An analog loopback test will then show no offset, because the application shifts the recorded data accordingly. Because in real world operation analog record and playback is unavoidable, the drivers include an offset value matching the Fireface's converter delays.

Therefore, in a **digital** loopback test a *negative* offset of about 3 ms occurs. This is no real problem, because this way of working is more than seldom, and usually the offset can be compensated manually within the application. Additionally, keep in mind that even when using the digital I/Os usually at some place an AD- and DA-conversion is involved (no sound without...).



---

Note: Cubase and Nuendo display the latency values signalled from the driver separately for record and playback. While with our former cards these values equalled exactly the buffer size (for example 3 ms at 128 samples), the Fireface displays an additional millisecond – the time needed for the AD/DA-conversion. Playback even shows another millisecond added – see Safety Buffer.

### Safety Buffer

FireWire audio differs significantly from RME's previous DMA technology. DMA access is not possible here. To be able to transmit audio reliably at lower latencies, FireWire requires a new concept – the *Safety Buffer*. The Fireface 800 uses a fixed additional buffer of 64 samples on the playback side only, which is added to the current buffer size. The main advantage is the ability to use lowest latency at highest CPU loads. Furthermore, the fixed buffer does not add to the latency jitter (see Tech Info), the subjective timing is extraordinary.

### Core Audio's Safety Offset

Under OS X, every audio interface has to use a so called *Safety Offset*, otherwise Core Audio won't operate click-free. The Fireface uses a safety offset of 64 samples. This offset is signalled to the system, and the software can calculate and display the total latency of buffer size plus AD/DA offset plus safety offset for the current sample rate.

## 35.3 FireWire Audio

FireWire audio is in several ways different from RME's earlier PCI audio interfaces. First of all, our cards have a PCI interface which has been developed by RME and optimized for audio. FireWire on the other hand, uses OHCI-compatible controllers that have not been optimized for audio, no matter from which manufacturer they are. Our PCI data transmission is per channel, while FireWire is working interleaved, i.e. it transmits all channels simultaneously. With the Hammerfall, drop-outs thus occur only on the last channels, which is not always noticeable, while a drop-out with FireWire always concerns all channels and is thus perceived much clearer. Apart from this, RME's PCI audio cards establish a direct connection with the application under ASIO (Zero CPU load), which is principally not possible with FireWire, because communication has to be established by the operating system's FireWire driver. Compared to our PCI cards, the FireWire subsystem creates an additional CPU load at lower latencies.

One Fireface 800 can achieve a performance similar to a PCI card with an optimal PC. An 'optimal' PC has an undisturbed PCI bus. Intel's motherboard D875PBZ e.g., has network, PATA and SATA connected directly to the chipset. No matter what you do with the computer, FireWire audio is not being disturbed. The same holds true for the ASUS P4C800, as long as you leave the additional SATA controller (PCI) unused.

Due to insufficient buffering within FireWire controllers, single peak loads on the PCI bus can already cause loss of one or more data packets. This is independent of the manufacturer and no RME problem. The Fireface 800 features a unique data checking, detecting errors during transmission via PCI/FireWire and displaying them in the Settings dialog. Additionally the Fireface provides a special mechanism which allows to continue record and playback in spite of drop-outs, and to correct the sample position in real-time.

Detailed information on this topic can be found in the Tech Info *FireWire Audio by RME – Technical Background* on our website:

[http://www.rme-audio.com/english/techinfo/fwaudio\\_rme.htm](http://www.rme-audio.com/english/techinfo/fwaudio_rme.htm)

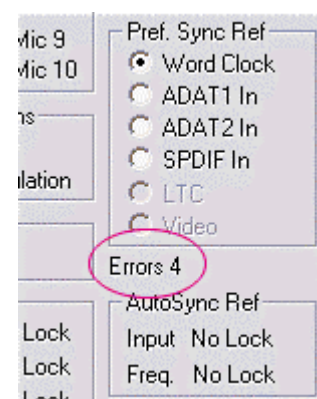

---

## 35.4 Number of Channels and Bus Load

As explained in chapter 35.3, FireWire Audio does not reach the same performance as PCI audio. On a standard computer with modern single PCI bus, about 100 audio channels can be transmitted per direction (record/playback). Exceeding this limit, any system activity - even outside the PCI bus - causes drop outs.

Transferring these experiences to FireWire and the Fireface 800 means that besides the number of channels the *bus load* has to be taken into account too. One channel at 96 kHz causes the same load to the system as two channels at 48 kHz!

To use FireWire as efficiently as possible, the Fireface allows to reduce the number of transferred channels. *Limit Bandwidth* provides four options, limiting the transmission internally to 28, 20, 12 or 8 channels. This limitation is independent from the sample rate, which is why the option's descriptions are not fully correct at 96 kHz. As can be seen in the following table, in 96 kHz mode there is no difference between the setting *All Channels* and *An.+SPDIF+ADAT1*. For a valid reduction of the bus load ADAT must be unselected completely. As the Fireface offers only 12 channels in Quad Speed mode, the options *All Channels* (28 channels) down to *Analog+SPDIF* (12 channels) perform no change at all. Logically, as ADAT isn't available in this mode anyway.

Limit Bandwidth	48 kHz (28)	96 kHz (20)	192 kHz (12)	FW-Channels
All Channels	x	/	/	28
An.+SPDIF+ADAT 1	x	x	/	20
Analog+SPDIF	x	x	x	12
Analog 1-8	x	x	x	8

The bus load is *doubled* at 96 kHz and *quadrupled* at 192 kHz. Limit Bandwidth sets a constant number of channels, but those channels cause a bigger load in DS and QS mode, because more data have to be transferred. For example the 12 channels at 192 kHz equal a FireWire and PCI bus load of 48 channels at 48 kHz! The following table shows the real bus load in all modes.

Limit Bandwidth	48 kHz (max 28)	DS (max. 20)	QS (max. 12)
All Channels	28	40	48
An.+SPDIF+ADAT 1	20	40	48
Analog+SPDIF	12	24	48
Analog 1-8	8	16	32

The usage of multiple Firefaces in DS and QS operation can be problematic due to the increased bus load. Some examples:

- 2 Firefaces will most likely not run stable at 192 kHz at full track count. 2 x 12 channels 192 kHz equal 2 x 48 channels at 48 kHz = 96 channels per direction.
- 2 Firefaces at 96 kHz should operate reliable at full channel count. 2 x 20 equals 2 x 40 = 80 channels per direction.
- 3 Firefaces at 96 kHz can't operate at full channel count (3 x 20 equals 3 x 40 = 120 channels per direction). The Settings dialog will show Errors, audio will sound distorted.
- To not exceed a maximum of 80 channels with 3 Firefaces at 96 kHz, a setting like *Analog+SPDIF* is recommended to be used on all Firefaces. This equals 3 x 24 = 72 channels per direction.

---

## 35.5 DS - Double Speed

When activating the *Double Speed* mode the Fireface 800 operates at double sample rate. The internal clock 44.1 kHz turns to 88.2 kHz, 48 kHz to 96 kHz. The internal resolution is still 24 bit.

Sample rates above 48 kHz were not always taken for granted, and are still not widely used because of the CD format (44.1 kHz) dominating everything. Before 1998 there were no receiver/transmitter circuits available that could receive or transmit more than 48 kHz. Therefore a work-around was used: instead of two channels, one AES line only carries one channel, whose odd and even samples are being distributed to the former left and right channels. By this, you get the double amount of data, i. e. also double sample rate. Of course in order to transmit a stereo signal two AES/EBU ports are necessary then.

This transmission mode is called *Double Wire* in the professional studio world, and is also known as *S/MUX (Sample Multiplexing)* in connection with the ADAT format.

Not before February 1998, Crystal shipped the first 'single wire' receiver/transmitters that could also work with double sample rate. It was then possible to transmit two channels of 96 kHz data via one AES/EBU port.

But *Double Wire* is still far from being dead. On one hand, there are still many devices which can't handle more than 48 kHz, e. g. digital tape recorders. But also other common interfaces like ADAT or TDIF are still using this technique.

Because the ADAT interface does not allow for sampling frequencies above 48 kHz (a limitation of the interface hardware), the Fireface 800 automatically uses *Sample Multiplexing* in DS mode. One channel's data is distributed to two channels according to the following table:

Analog In	1	2	3	4	5	6	7	8
DS Signal Port	1/2 ADAT1	3/4 ADAT1	5/6 ADAT1	7/8 ADAT1	1/2 ADAT2	3/4 ADAT2	5/6 ADAT2	7/8 ADAT2

As the transmission of double rate signals is done at standard sample rate (Single Speed), the ADAT outputs still deliver 44.1 kHz or 48 kHz.

## 35.6 QS – Quad Speed

Due to the small number of available devices that use sample rates up to 192 kHz, but even more due to a missing real world application (CD...), Quad Speed has had no broad success so far. An implementation of the ADAT format as double S/MUX results in only two channels per optical output. There are few devices using this method.

The Fireface 800 can not provide ADAT at 192 kHz, because this would equal a channel count of 64 (10+2+2+2 x 4, see chapter 35.4, Number of Channels and Bus load). The Fireface is internally limited to 48 channels.

The SPDIF (AES) output of the Fireface 800 provides 192 kHz as Single Wire only.

### 35.7 AES/EBU - SPDIF

The most important electrical properties of 'AES' and 'SPDIF' can be seen in the table below. AES/EBU is the professional balanced connection using XLR plugs. The standard is being set by the *Audio Engineering Society* based on the AES3-1992. For the 'home user', SONY and Philips have omitted the balanced connection and use either Phono plugs or optical cables (TOSLINK). The format called S/P-DIF (SONY/Philips Digital Interface) is described by IEC 60958.

Type	AES3-1992	IEC 60958
Connection	XLR	RCA / Optical
Mode	Balanced	Un-balanced
Impedance	110 Ohm	75 Ohm
Level	0.2 V up to 5 V <sub>ss</sub>	0.2 V up to 0.5 V <sub>ss</sub>
Clock accuracy	not specified	I: ± 50ppm II: 0,1% III: Variable Pitch
Jitter	< 0.025 UI (4.4 ns @ 44.1 kHz)	not specified

Besides the electrical differences, both formats also have a slightly different setup. The two formats are compatible in principle, because the audio information is stored in the same place in the data stream. However, there are blocks of additional information, which are different for both standards. In the table, the meaning of the first byte (#0) is shown for both formats. The first bit already determines whether the following bits should be read as Professional or Consumer information.

Byte	Mode	Bit 0	1	2	3	4	5	6	7
0	Pro	P/C	Audio?		Emphasis		Locked	Sample Freq.	
0	Con	P/C	Audio?	Copy	Emphasis			Mode	

It becomes obvious that the meaning of the following bits differs quite substantially between the two formats. If a device like a common DAT recorder only has an SPDIF input, it usually understands only this format. In most cases, it will switch off when being fed Professional-coded data. The table shows that a Professional-coded signal would lead to malfunctions for copy prohibition and emphasis, if being read as Consumer-coded data.

Nowadays many devices with SPDIF input can handle Professional subcode. Devices with AES3 input almost always accept Consumer SPDIF (passive cable adapter necessary).

### 35.8 Noise level in DS / QS Mode

The outstanding signal to noise ratio of the Fireface's AD-converters can be verified even without expensive test equipment, by using record level meters of various software. But when activating the DS and QS mode, the displayed noise level will rise from -109 dB to -104 dB at 96 kHz, and -82 dB at 192 kHz. This is not a failure. The software measures the noise of the whole frequency range, at 96 kHz from 0 Hz to 48 kHz (RMS unweighted), at 192 kHz from 0 Hz to 96 kHz.

When limiting the measurement's frequency range to 22 kHz (audio bandpass, weighted) the value would be -110 dB again. This can be verified even with RME's Windows tool *DIGiCheck*. Although a dBA weighted value does not include such a strong bandwidth limitation as audio bandpass does, the displayed value of -108 dB is nearly identical to the one at 48 kHz.

Subframe	MSB	Audio Data	LSB	AUX	CUV	RMS [dB+3]	RMS [dBA+3]	DC [dB]
1 - Left	XXXXXXXXXX	XXXXXXXXXX	XXXXXXXXXX	XXXXXXXXXX	00	-81.9	-108.5	LOW
2 - Right	XXXXXXXXXX	XXXXXXXXXX	XXXXXXXXXX	XXXXXXXXXX	00	-82.1	-108.9	LOW
Bits	4	8	12	16	20			

The reason for this behaviour is the noise shaping technology of the analog to digital converters. They move all noise and distortion to the in-audible higher frequency range, above 24 kHz. That's how they achieve their outstanding performance and sonic clarity. Therefore the noise is slightly increased in the ultrasound area. High-frequent noise has a high energy. Add the doubled (quadrupled) bandwidth, and a wideband measurement will show a significant drop in SNR, while the human ear will notice absolutely no change in the audible noise floor.

### 35.9 SteadyClock

The SteadyClock technology of the Fireface 800 guarantees an excellent performance in all clock modes. Thanks to a highly efficient jitter suppression, the AD- and DA-conversion always operates on highest sonic level, being completely independent from the quality of the incoming clock signal.

SteadyClock has been originally developed to gain a stable and clean clock from the heavily jittery MADi data signal (the embedded MADi clock suffers from about 80 ns jitter). Using the Fireface's input signals SPDIF and ADAT, you'll most probably never experience such high jitter values. But SteadyClock is not only ready for them, it would handle them just on the fly.

Common interface jitter values in real world applications are below 10 ns, a very good value is less than 2 ns.

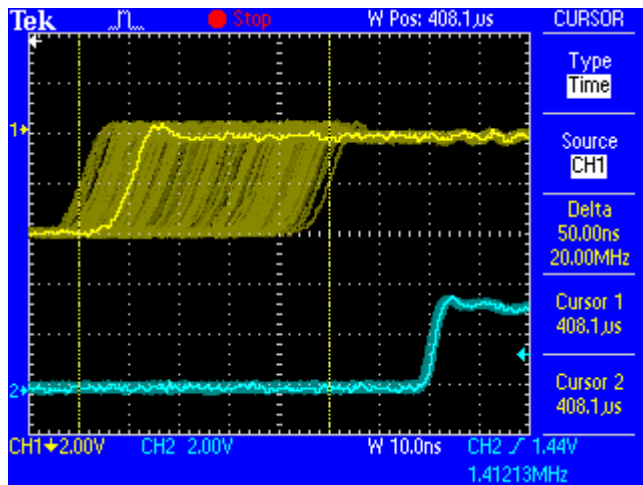

The screenshot shows an extremely jittery SPDIF signal of about 50 ns jitter (top graph, yellow). SteadyClock turns this signal into a clock with less than 2 ns jitter (lower graph, blue). The signal processed by SteadyClock is of course not only used internally, but also used to clock the digital outputs. Therefore the refreshed and jitter-cleaned signal can be used as reference clock without hesitation.

## 36. Diagrams

### 36.1 Block Diagram Fireface 800

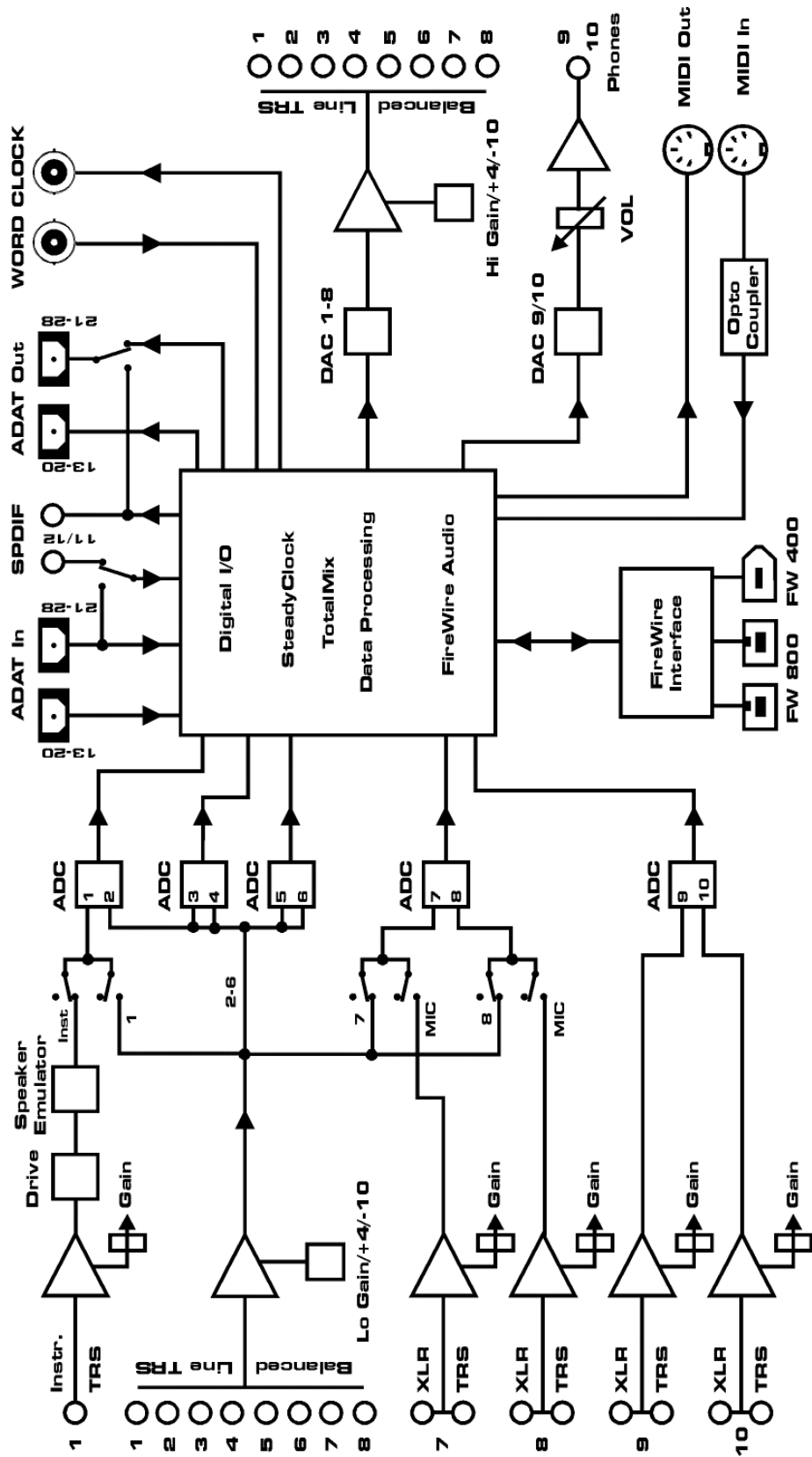

---

## 36.2 Connector Pinouts

### TRS jacks of analog input / output

The stereo ¼" TRS jacks of the analog inputs and outputs are wired according to international standards:

Tip = + (hot)  
Ring = - (cold)  
Sleeve = GND

The servo balanced input and output circuitry allows to use monaural TS jacks (unbalanced) with no loss in level. This is the same as when using a TRS-jack with ring connected to ground.

### XLR jacks of analog inputs

The XLR jacks are wired according to international standards:

1 = GND (shield)  
2 = + (hot)  
3 = - (cold)

### TRS Phones jack

The analog monitor output on the front is accessible through a stereo ¼" TRS jack. This allows a direct connection of headphones. In case the output should operate as Line output, an adapter TRS plug to RCA phono plugs, or TRS plug to TS plugs is required.

The pin assignment follows international standards. The left channel is connected to the tip, the right channel to the ring of the TRS jack/plug.

